

TemBreak^{PRO}

P Model Moulded Case Circuit Breaker

Thermal Magnetic Trip Unit from 160A up to 630A

USER MANUAL



Version
1.5.1

Using this manual

Safety Precautions

Authorised Personnel Only

The product or system described in this documentation must be installed, operated and maintained by qualified personnel only. NHP or Terasaki accept no responsibility for the consequences of the use of this equipment by unqualified personnel.

A qualified person is one with the necessary skills and knowledge of the construction and operation of the installation of electrical equipment and has been trained to identify and avoid risks.

Appropriate use of NHP / Terasaki products

NHP / Terasaki products are intended to be used only for the applications described in the catalogue and technical documentation, which is dedicated to them. If products and components from other manufacturers are used, they must be recommended or approved by NHP or Terasaki.

Appropriate use of NHP / Terasaki products during transport, storage, installation, assembly, commissioning, operation and maintenance is necessary to ensure safe operation and without any problems.

The permissible ambient conditions must be met. The information contained in the technical documentation must be observed.

Publication of responsibility

The contents of this document have been reviewed to ensure that the reliability of the information is correct at time of publication.

NHP or Terasaki are not responsible for printing or damage resulting from errors. NHP or Terasaki reserve the right to make corrections and changes needed in subsequent edition.

Warnings and notes

This documentation contains safety instructions that you must follow for your personal safety and to prevent damage to property.

Safety instructions, referring to your personal safety are reported in the literature by a safety alert symbol.

Safety warning symbols and the words below are classified according to the degree of risk.



WARNING: Indicates an imminently hazardous situation which, if it cannot be avoided, will result in death or serious injury.



WARNING: Indicates a potentially hazardous situation which, if it cannot be avoided, can result serious injury or death.



WARNING: Indicates a potentially hazardous situation which, if it cannot be avoided, may cause minor or moderate injury.



Notice: Indicates a warning of property damage and can also indicate important operating and especially useful information on the product, that it should pay particular attention to efficient and safe operation.

Summary of Changes

This section highlights the details of changes made since the previous issue of this document.

The versioning convention used to track changes in this document follows the structure **Vx.y.z** where:

x: Major revision, where extensive changes are made which is generally incompatible with the previous version. Such changes may include new products and/or features, or removal of information which is no longer relevant or applicable to the previous version

y: Minor revision, where changes made do not change the overall scope of the previous version, but may include additional information which complements or corrects the previous version, or provides additional clarity on an existing topic.

z: Patch version, where small changes are made to correct minor errors or adjust existing text, charts, figures and/or images, and which do not add or remove information from the previous version. Example changes may include spelling corrections, image re-sizing and adjustments, updated images, etc.

Version	Publication date	Changes	By
V 1.0.0	21-Apr-2021	Initial release	D.NAT
V 1.0.1	26-Apr-2021	Spelling and formatting	D.NAT
V 1.1.0	29-Apr-2021	Added Troubleshooting section	D.NAT
V 1.2.0	13-May-2021	Clearance distance corrections	N.ALEX
V 1.3.0	28-May-2021	Label Identification section added, product information correction, Temperature Rating tables aligned headings with TD-001-EN, I ² t Curves updated in image quality, added references and links to, TD-001-EN, TD-002-EN, TD-003-EN, & Type2_TBpro_MotorStartTables-TD-001-EN	N.ALEX
V 1.4.0	20-August-2021	Correction to P160 Information table data, correction to P400 magnetic dial settings, added resistance watts loss, fixed typo on Part Number Break Down, rewording in Clearance section links to Installation Manuals added	N.ALEX
V 1.5.0	20-Jan-2022	Changed watts loss and temperature tables to match TD-001-EN, Further clarification on thermal dial adjustment calibration points.	N.ALEX
V 1.5.1	11-May-2022	Corrections to li settings	N.ALEX

Table of Contents

Using this manual	2	Commissioning	33
Safety Precautions	2	Thermal Setting (I_r)	33
Summary of Changes	3	Magnetic Setting (I_i)	34
Table of Contents	4	Neutral Protection Setting (N)	35
Introduction	5	Troubleshooting	36
Who Should Use This Manual?	5	Annex A – Dimensions	37
Additional resources	5	P160 Dimensions	37
Terminology and Abbreviations	6	P250 Dimensions	38
Product Information	7	P400 Dimensions	39
Part Number Break Down	8	P630 Dimensions	40
Available MCCBs in the TemBreak <i>PRO</i> range:	9	Annex B – Trip Curves	41
Label Identification	10	P160F / N / H	41
P160_TM Information	11	P250F / N / H	42
P250_TM Information	12	P400E / F / N / H / S	43
P400_TM Information	13	P630E / F / N / H / S	44
P630_TM Information	14	Annex C – I^2t Let Through Curves	45
Internal Accessories	15	P160F / N / H	45
Auxiliary & Alarm Switches	15	P250F / N / H	46
Auxiliary Contact	15	P400E / F / N / H / S	47
Alarm Contact	15	P630E / F / N / H / S	48
Shunt Trip	16	Annex D – Peak Let Through Curves	49
Under Voltage Trips	16	P160F / N / H	49
Installation	17	P250F / N / H	50
Precautions	17	P400E / F / N / H / S	51
Mounting Angles	17	P630E / F / N / H / S	51
Direction of Power Supply	17	Annex E – Watts Loss	52
Clearances	18	Impedance Watts Loss	52
Internal Accessory Mounting Locations	20	Resistance Watts Loss	53
P160 internal accessories combination	20	Annex F – Temperature Derating	54
P250 internal accessories combination	21	Front & Rear Connect	54
P400/630 internal accessories combination	22	Plug-in Connect	55
Alarm, Shunt & UVT Installation	23		
Standard Alarm & Auxiliary installation	23		
Shunt & UVT installation	24		
Protection Settings	25		
Trip Curve	25		
Thermal protection	26		
TM – Adjusting I_r (Current)	26		
FF – Fixed I_r (Current)	27		
Labelling of Calibrated Points	27		
Magnetic Protection	28		
TM – Adjusting I_i (Current)	28		
FF – Fixed I_i (Current)	29		
Neutral Protection	31		
Temperature Ratings	32		

Introduction

This user manual describes the TemBreak *PRO* Thermal Magnetic (**P_TM**) MCCB features and instructions for use, and provides information for commissioning and configuring.

Some additional features may require the use of additional products and accessories to achieve full utilization of that feature. Refer the respective User Manual in the TemBreak *PRO* series for additional information on the respective product.



Notice: Not all MCCBs in the TemBreak *PRO* series are identical. This document specifically covers the P_TM series MCCB only. Refer to the respective TemBreak *PRO* User Manual (e.g. B_SE, P_SE, etc.) for information and instructions on other models in the TemBreak *PRO* range.

Who Should Use This Manual?

This manual aims to provide users, electricians, panel builders and maintenance personnel, with the technical information required for commissioning and operation of the NHP / Terasaki TemBreak *PRO* P_TM MCCB.

Users of this document must have at minimum a basic understanding of electrical circuit protection topics including (but not limited to):

- Power distribution and reticulation
- Circuit protection devices
- Fault currents
- Arc faults
- Temperature rise and thermal derating of switchgear

Additional resources

The following resources contain additional information which should be read in conjunction with this document.

Resource	Description
NHP/Terasaki TemBreak <i>PRO</i> P_TM Installation Instructions P160_3_TM-IN-001-EN P160_4_TM-IN-001-EN P250_3_TM-IN-001-EN P250_4_TM-IN-001-EN P400_3_TM-IN-001-EN P400_4_TM-IN-001-EN P630_3_TM-IN-001-EN P630_4_TM-IN-001-EN	Information on installing, mounting, and wiring the TemBreak <i>PRO</i> Thermal Magnetic MCCB.
Technical Data – Temperature and Watts Loss TBP-TD-001-EN	Temperature and Watts Loss tables for TemBreak <i>PRO</i> Moulded Case Circuit Breakers.
Technical Data – Cascading and Selectivity TBP-TD-002-EN	Cascading and Selectivity tables for TemBreak <i>PRO</i> Moulded Case Circuit Breakers with Din-T, Din-Safe, & MOD6 MCBs/RCBOs
Technical Data – Coordination TBP-TD-003-EN	Socomec Backup Tables with TemBreak <i>PRO</i> Moulded Case Circuit Breakers
Technical Data – Type 2 Coordination Type2_TBpro_MotorStartTables-TD-001-EN	Type 2 Coordination for Premium Efficiency Motor Starters with TemBreak <i>PRO</i> Moulded Case Circuit Breakers

Introduction

Terminology and Abbreviations

Abbreviation	Description	Abbreviation	Description
ACP	Auxiliary Communications port: Plug for Smart auxiliary / alarm contact block	MIP	Maintenance Interface Port: Plug for temporary connection to OCR testing, servicing, and maintenance tools
AL	Alarm: An auxiliary contact indicating trip status	N	Neutral
ASCII	American Standard Code for Information Interchange	NP	Neutral Protection
AX or AUX	Auxiliary: Auxiliary contact indicating open / closed	OAC	Optional Alarm Contact: Connection connector optional alarm output contact
BE	Basic Electronic Trip Unit (dial type, LSI and LSIG)	OCR	Over Current Relay
CCW	Connected Components Workbench software	P or PTA	Pre-trip Alarm
CIP ^{1 2}	¹ Communication Interface Port: Plug for control power and data for use with the TPED remote display and TPCM communication module ² Common Industrial Protocol	PDU	Protocol Data Unit
CRC	Cyclic Redundancy Check – error-detecting code used at the end of each Modbus message	PELV	Protected Extra Low Voltage (earthed system)
dec	Decimal (base-10) numbering system	PTA	Pre-Trip Alarm: is a programmable output contact to advise when a trip may be imminent.
DINT	Signed Double Integer datatype (4 bytes or 32 bits in length)	RTU	Remote Terminal Unit
EIPM	TemBreak <i>PRO</i> Ethernet/IP Module	S or STD	Short Time Delay Protection
FF	Fixed Thermal and Fixed Magnetic	SE	Smart Energy Trip Unit
FM	Fixed Thermal and Adjustable Magnetic	SELV	Separated Extra Low Voltage
G or GF	Ground Fault Protection	SN	Solid Neutral
hex	Hexadecimal (base-16) numbering system	SSID	Service Set Identifier (name of the Wi-Fi wireless network)
I or INST	Instantaneous Protection	STR	String datatype
IEC	International Electrotechnical Commission	TCP	Transmission Control Protocol
IEEE	Institute of Electrical and Electronics Engineers	TF	Adjustable Thermal and Fixed Magnetic
I_g	Ground Fault Protection Current	THD	Total Harmonic Distortion
I_i	Instantaneous Protection Current	TM	Adjustable Thermal Magnetic
I_n	Rated Current	TPCM	TemCom <i>PRO</i> Communication Module
I_N	Neutral Protection Current	TPED	TemView <i>PRO</i> External Display
INT	Signed Integer datatype (2 bytes or 16 bits in length)	t_r	LTD Time delay
IP	International Protection (Ingress Protection)	t_{sd}	STD Time delay
I_r	LTD Protection Current	t_{tsp}	Thermal Self-Protection Time delay
I_{sd}	STD Protection Current	UDINT	Unsigned Integer (2 bytes or 16-bits in length)
I_{tsp}	Thermal Self-Protection Current	UINT	Unsigned Integer (2 bytes or 16 bits in length)
L or LTD	Long Time Delay Protection	ULINT	Unsigned Long Integer datatype (8 bytes or 64 bits in length)
LCD	Liquid Crystal Display (LCD)	URLs	Uniform Resource Locator (address of an Internet website)
LED	Light Emitting Diode	WORD	2 bytes or 16-bits of data
LINT	Signed Long Integer datatype (8 bytes or 64 bits in length)	ZSI	Zone Selective Interlocking (zone selectivity)
LSI	Long Time, Short Time and Instantaneous Protection	θ	Thermal imaging value
LSIG	Long Time, Short Time, Instantaneous and Ground Fault Protection	θ_c	Cold start mode thermal imaging value
MCCB	Moulded Case Circuit Breaker	θ_H	Hot start mode thermal imaging value
microSD	Micro Secure Digital	θ_{trip}	Thermal imaging value tripping threshold

Product Information

The TemBreak *PRO* P model Thermal Magnetic MCCB with trip unit type P_TM and P_FF offers protection against overloads and short circuits. The TM type features adjustable protection settings via preset rotary switches, providing adjustable thermal and magnetic tripping curves. This allows for improved selectivity combinations between MCCBs or other circuit breaker types. The FF type features non-adjustable fixed thermal and fixed magnetic tripping curves.

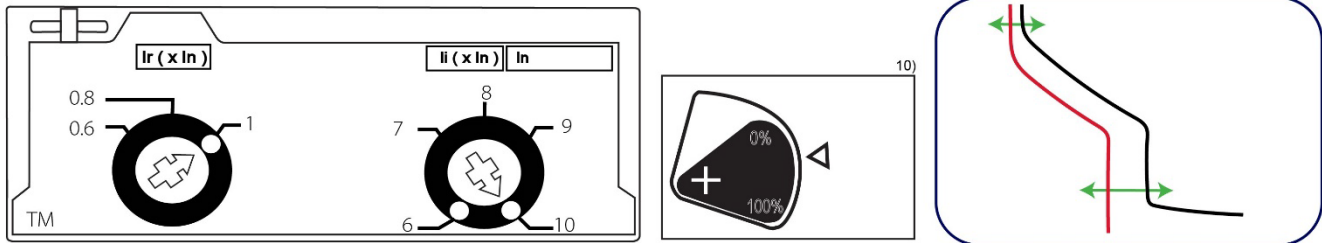

Features (TM – adjustable)

- Settings accessible by a rotary dial
- Thermal element & Magnetic element adjustment dials
- Possible adjustment of the protection of neutral pole on 4-pole versions (neutral pole positioned to the right)
- 4-pole thermal magnetic MCCBs, will include Neutral pole protection as standard.
- Switched Neutral (4P only) with early make/late break design which reduces the risk of abnormal line to neutral voltages that may damage sensitive electronic equipment.
- Magnetic Only versions available.

Features (FF – fixed)

- Non-adjustable thermal & non-adjustable magnetic trip curves
- 2 Pole for AC and DC applications

Frame Sizes

- P160
 - P250*
 - P400*
 - P630*
- (*TM only)

Protection Functions

- Thermal – Long Time Delay
- Magnetic – Instantaneous
- Neutral Protection (4P only)

Product Information

Part Number Break Down



a) Model Type

A	Basic applications (160...250 A)
P	Mid to advanced applications (160...630 A)
B	High current, high kA applications (160...1600 A)
ZS	Earth Leakage applications (125...250 A)
XS	Highest current applications (2000...3200 A)

b) Ampere Frame

125 A
160 A
250 A
400 A
630 A
800 A
1000 A
1250 A
1600 A
2000 A
2500 A
3200 A

c) Short Circuit Break Capacity I_{cu} (kA)

R	200 kA
L	150 kA
P	125 kA
S	110 kA
G	100 kA
HL	85 kA
H	70 kA
M	65 kA
N	50 kA
F	36 kA
E	25 kA
D	Switch

d) Pole Pitch Size (mm) ¹⁾

1	25
2	30
3	35

e) No. of Poles

1	⁷⁾
2	⁸⁾
3	
4	

f) Trip Unit Rating (I_n)

I_n x A

g) Trip Unit Type

TF	Adj Thermal Fix Magnetic ⁴⁾
FF	Fix Thermal Fix Magnetic
TM	Adj Thermal Adj Magnetic
SX	Smart Ammeter ^{5) 6)}
BE	Basic Electronic ⁶⁾
SE	Smart Energy ⁶⁾
NN	Non-Auto Switch

h) Trip Unit Option

G	Ground Fault ²⁾
N	Neutral ²⁾
P	Pre-Trip Alarm ³⁾
SN	Solid Neutral ⁹⁾



Notice: Not all combinations are possible. Confirm part number combination with NHP for availability.

- 160AF only
- For P_SE versions these features are standard and therefore are not added to the end of the part number.
- PTA is standard with P electronic models and therefore P is not added to the end of the part number.
- Only available in A & ZS models
- Only available in B models
- Not available in A and ZS models
- Only available in A and B models (FF Only Trip Unit)
- Not available in A and B models (FF Only Trip Unit)
- ZS Models

Product Information

Available MCCBs in the TemBreak *PRO* range:



Rating Short Circuit Break Capacity (kA)		Frame Size											
		160	250	400	630	800	1000	1250	1600	2000	2500	3200	
E	25	A160E – TF A160E – FF B160E – FF	A250E – TM	P400E-TM	P630E – TM								
F	36	A160F – TF P160F – FF P160F – TM P160F – BE P160F – BEG P160F – SE	A250F – TM P250F – TM P250F – BE P250F – BEG P250F – SE	P400F – TM P400F – BE P400F – BEG P400F – SE	P630F – TM P630F – BE P630F – BEG P630F – SE	B800F – TM							
N	50	P160N – TM P160N – BE P160N – BEG P160N – SE	P250N – TM P250N – BE P250N – BEG P250N – SE	P400N – TM P400N – BE P400N – BEG P400N – SE	P630N – TM P630N – BE P630N – BEG P630N – SE	B800N – TM B800N – BE B800N – SX B800N – SE	B1000N – BE B1000N – BEG B1000N – SX B1000N – SE	B1250N – BE B1250N – BEG	B1600N – BE B1600N – BEG				
H	70	P160H – TM P160H – BE P160H – BEG P160H – SE	P250H – TM P250H – BE P250H – BEG P250H – SE	P400H – TM P400H – BE P400H – BEG P400H – SE	P630H – TM P630H – BE P630H – BEG P630H – SE	B800H – TM B800H – BE B800H – BEG B800H – SX B800H – SE	B1000H – BE B1000H – BEG B1000H – SX B1000H – SE	B1250H – BE B1250H – BEG					
HL	85							B1250HL – BE B1250HL – BEG	B1600HL – BE B1600HL – BEG	XS2000HL – BE XS2000HL – BEG	XS2500HL – BE XS2500HL – BEG	XS3200HL – BE	
G	100					B800G – TM B800G – BE B800G – BEG B800G – SX B800G – SE							
S	110			P400S – TM P400S – BE P400S – BEG P400S – SE	P630S – TM P630S – BE P630S – BEG P630S – SE								
P	125	B160P – TM	B250P – TM B250P – BE B250P – SE	B400P – BE B400P – BEG		B800P – BE B800P – BEG B800P – SX B800P – SE							
R	200	B160R – TM	B250R – TM	B400P – BE B400P – BEG		B800R – BE B800R – BEG B800R – SX B800R – SE							
D	Switch	A160D – NN P160D – NN	A250D – NN P250D – NN	P400D – NN	P630D – NN	B800D – NN	B1000D – NN	B1250D – NN	B1600D – NN	XS2000D – NN	XS2500D – NN		

Product Information

Label Identification

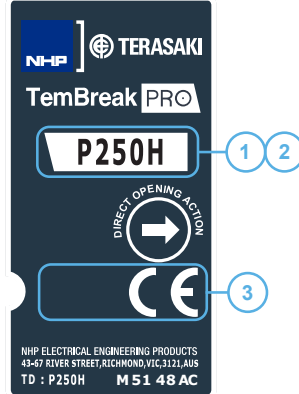
The label on the MCCB features information to aid in product identification.



Description	Notes																		
1 Circuit Break Identifier	Identifies the model type, ampere frame, and I _{cu} rating.																		
2 Trip unit type	<p>The trip unit type is indicated by the colour of the label.</p> <div style="display: flex; align-items: flex-start;"> <div style="margin-right: 20px;">  </div> <div> <p>White label – Thermal-magnetic type trip unit</p> <table border="1"> <tr> <td>Trip Units</td> <td>FF, TF, FM, TM</td> </tr> <tr> <td>Models</td> <td>A, P, B, ZS</td> </tr> <tr> <td>Ampere Frame</td> <td>125 – 800</td> </tr> </table> </div> </div> <div style="margin-top: 20px;">  <div style="margin-left: 20px;"> <p>Grey label – electronic or non-auto type trip unit. To distinguish between the two, electronic trip units will have the “I_{cu}” letter and non-auto will use the letter “D”, Switch.</p> <table border="1"> <tr> <td>Trip Units</td> <td>BE, BEG, BEGN, NN</td> </tr> <tr> <td>Models</td> <td>A, P, B, XS</td> </tr> <tr> <td>Ampere Frame</td> <td>160 – 3200</td> </tr> </table> </div> </div> <div style="margin-top: 20px;">  <div style="margin-left: 20px;"> <p>Blue Label – SMART electronic type trip unit</p> <table border="1"> <tr> <td>Trip Units</td> <td>SX, SE</td> </tr> <tr> <td>Models</td> <td>P, B</td> </tr> <tr> <td>Ampere Frame</td> <td>160 – 1000</td> </tr> </table> </div> </div>	Trip Units	FF, TF, FM, TM	Models	A, P, B, ZS	Ampere Frame	125 – 800	Trip Units	BE, BEG, BEGN, NN	Models	A, P, B, XS	Ampere Frame	160 – 3200	Trip Units	SX, SE	Models	P, B	Ampere Frame	160 – 1000
Trip Units	FF, TF, FM, TM																		
Models	A, P, B, ZS																		
Ampere Frame	125 – 800																		
Trip Units	BE, BEG, BEGN, NN																		
Models	A, P, B, XS																		
Ampere Frame	160 – 3200																		
Trip Units	SX, SE																		
Models	P, B																		
Ampere Frame	160 – 1000																		
3 Certifications	Identifies the additional localised certifications of the product, in addition to the international product standard, IEC 60947-2 / AS/NZS IEC 60947-2. For additional certifications please contact NHP.																		

Product Information

P160_TM Information

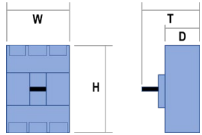
Frame / Model	Attribute	Unit	Condition	P160F_FF	P160F_TM	P160N_TM	P160H_TM
Number of Poles				2	3, 4	3, 4	3, 4
Nominal current ratings	I_{CT}	(A)	50°C Calibration	15, 20,	20, 32,	20, 32,	20, 32,
Trip unit ratings				30, 40, 50, 60, 75, 100, 125	50, 63, 100, 125, 160	50, 63, 100, 125, 160	50, 63, 100, 125, 160
Electrical characteristics							
Rated maximum operational voltage	U_e	(V)	AC 50/60 Hz DC	690	690	690	690
		(V)		250	250	250	250
Rated insulation voltage	U_i	(V)		800	800	800	800
Rated impulse withstand voltage	U_{imp}	(kV)		8	8	8	8
Selectivity category				A	A	A	A
Rated short time withstand current	I_{cw}	(kA)	0.4 sec	—	—	—	—
Ultimate breaking capacity (IEC, JIS, AS/NZS)	I_{cu}	(kA)	690 Vac	6	6	6	6
			400 /415 Vac	36	36	50	70
			240 Vac	50	50	85	85
DC Voltage			250 Vdc	25	25	40	40
Service breaking capacity (IEC, JIS, AS/NZS)	I_{cs}	(kA)	690 Vac	6	6	6	6
			400 /415 Vac	36	36	50	50
			240 Vac	50	50	85	85
DC Voltage			250 Vdc	19	19	40	40
Protection - Over Current Release types	Std Standard Opt Optional — Not Available M Req Module Required						
Fixed thermal magnetic				Std	—	—	—
Adjustable thermal, adjustable magnetic				—	Std	Std	Std
Installation (Std / Opt / —)							
Front connection (FC)				Std	Std	Std	Std
Extension bar (FB)				Opt	Opt	Opt	Opt
Cable tunnel clamp (FW)				Opt	Opt	Opt	Opt
Rear Connection (RC)				Opt	Opt	Opt	Opt
DIN rail adaptor				Opt	Opt	Opt	Opt
Withdrawable mechanism				—	Opt	Opt	Opt
Plug-in				—	Opt	Opt	Opt
Reverse supply connection possible to 440V				Yes	Yes	Yes	Yes
Dimensions							
	H	(mm)		130	130	130	130
	W	(mm)	1 pole	—	—	—	—
			2 pole	60	—	—	—
			3 pole	—	90	90	90
			4 pole	—	120	120	120
	D	(mm)		68	68	68	68
	T	(mm)		95.5	95.5	95.5	95.5
Weight	W	(kg)	1 pole	—	—	—	—
			2 pole	0.7	—	—	—
			3 pole	—	1.0	1.0	1.0
			4 pole	—	1.3	1.3	1.3
Operation options (Std / Opt / —)	Std Standard Opt Optional — Not Available						
Toggle operation				Std	Std	Std	Std
Extension handle TP-HS/HP or Direct mount T2HB				—	Opt	Opt	Opt
Motor operation TP-MC				—	Opt	Opt	Opt
Endurance	Electrical	Cycles	415 Vac	30000	30000	30000	30000
	Mechanical	Cycles		50000	50000	50000	50000

Product Information

P250_TM Information

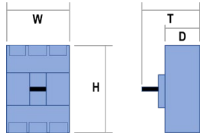
Frame / Model	Attribute	Unit	Condition	P250F_TM	P250N_TM	P250H_TM
Number of Poles				3, 4	3, 4	3, 4
Nominal current ratings	I_{CT}	(A)	50°C Calibration	50, 63	50, 63	50, 63
Trip unit ratings				100, 125 160, 250	100, 125 160, 250	100, 125 160, 250
Electrical characteristics						
Rated maximum operational voltage	U_e	(V)	AC 50/60 Hz DC	690	690	690
		(V)		250	250	250
Rated insulation voltage	U_i	(V)		800	800	800
Rated impulse withstand voltage	U_{imp}	(kV)		8	8	8
Selectivity category				A	A	A
Rated short time withstand current	I_{cw}	(kA)	0.4 sec	—	—	—
Ultimate breaking capacity (IEC, JIS, AS/NZS)	I_{cu}	(kA)	690 Vac	6	6	6
			400 /415 Vac	36	50	70
			220 /240 Vac	50	85	85
DC Voltage			250 Vdc	25	40	40
Service breaking capacity (IEC, JIS, AS/NZS)	I_{cs}	(kA)	690 Vac	6	6	6
			400 /415 Vac	36	50	50
			220 /240 Vac	50	85	85
DC Voltage			250 Vdc	19	40	40
Protection - Over Current Release types	Std Standard Opt Optional — Not Available M Req Module Required					
Fixed thermal magnetic				—	—	—
Adjustable thermal, adjustable magnetic				Std	Std	Std
Installation (Std / Opt / —)						
Front connection (FC)				Std	Std	Std
Extension bar (FB)				Opt	Opt	Opt
Cable tunnel clamp (FW)				Opt	Opt	Opt
Rear Connection (RC)				Opt	Opt	Opt
DIN rail adaptor				—	—	—
Withdrawable mechanism				Opt	Opt	Opt
Plug-in				Opt	Opt	Opt
Reverse supply connection possible to 440V				Yes	Yes	Yes
Dimensions						
	H	(mm)		165	165	165
	W	(mm)	1 pole	—	—	—
			2 pole	—	—	—
			3 pole	105	105	105
			4 pole	140	140	140
	D	(mm)		68	68	68
	T	(mm)		95.5	95.5	95.5
Weight	W	(kg)	1 pole	—	—	—
			2 pole	—	—	—
			3 pole	1.5	1.5	1.5
			4 pole	2.0	2.0	2.0
Operation options (Std / Opt / —)	Std Standard Opt Optional — Not Available					
Toggle operation				Std	Std	Std
Extension handle TP-HS/HP or Direct mount T2HB				Opt	Opt	Opt
Motor operation TP-MC				Opt	Opt	Opt
Endurance	Electrical	Cycles	415 Vac	10000	10000	10000
	Mechanical	Cycles		30000	30000	30000

Product Information

P400_TM Information

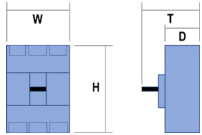
Frame / Model	Attribute	Unit	Condition	P400E_TM	P400F_TM	P400N_TM	P400H_TM	P400S_TM
Number of Poles				3, 4	3, 4	3, 4	3, 4	3, 4
Nominal current ratings	I_{CT}	(A)	50°C	250	250	250	250	250
Trip unit ratings			Calibration	400	400	400	400	400
Electrical characteristics								
Rated maximum operational voltage	U_e	(V)	AC 50/60 Hz	690	690	690	690	690
			DC	250	250	250	250	250
Rated insulation voltage	U_i	(V)		800	800	800	800	800
Rated impulse withstand voltage	U_{imp}	(kV)		8	8	8	8	8
Selectivity category				A	A	A	A	A
Rated short time withstand current	I_{cw}	(kA)	0.4 sec	—	—	—	—	—
Ultimate breaking capacity (IEC, JIS, AS/NZS)	I_{cu}	(kA)	690 Vac	—	7	12	12	12
			400 /415 Vac	25	36	50	70	110
			220 /240 Vac	35	50	85	100	125
DC Voltage			250 Vdc	25	25	50	50	50
Service breaking capacity (IEC, JIS, AS/NZS)	I_{cs}	(kA)	690 Vac	—	7	12	12	12
			400 /415 Vac	25	36	50	70	110
			220 /240 Vac	35	50	85	100	125
DC Voltage			250 Vdc	25	25	50	50	50
Protection - Over Current Release types	Std Standard Opt Optional — Not Available M Req Module Required							
Fixed thermal magnetic				—	—	—	—	—
Adjustable thermal, adjustable magnetic				Std	Std	Std	Std	Std
Installation (Std / Opt / —)								
Front connection (FC)				Std	Std	Std	Std	Std
Extension bar (FB)				Opt	Opt	Opt	Opt	Opt
Cable tunnel clamp (FW)				Opt	Opt	Opt	Opt	Opt
Rear Connection (RC)				Opt	Opt	Opt	Opt	Opt
DIN rail adaptor				—	—	—	—	—
Withdrawable mechanism				Opt	Opt	Opt	Opt	Opt
Plug-in				Opt	Opt	Opt	Opt	Opt
Reverse supply connection possible to 440V				Yes	Yes	Yes	Yes	Yes
Dimensions								
	H	(mm)		260	260	260	260	260
	W	(mm)	1 pole	—	—	—	—	—
			2 pole	—	—	—	—	—
			3 pole	140	140	140	140	140
			4 pole	185	185	185	185	185
	D	(mm)		103	103	103	103	103
	T	(mm)		151	151	151	151	151
Weight	W	(kg)	1 pole	—	—	—	—	—
			2 pole	—	—	—	—	—
			3 pole	4.3	4.3	4.3	4.3	4.3
			4 pole	5.7	5.7	5.7	5.7	5.7
Operation options (Std / Opt / —)	Std Standard Opt Optional — Not Available							
Toggle operation				Std	Std	Std	Std	Std
Extension handle TP-HS/HP or Direct mount T2HB				Opt	Opt	Opt	Opt	Opt
Motor operation TP-MC				Opt	Opt	Opt	Opt	Opt
Endurance	Electrical	Cycles	415 Vac	6000	6000	6000	6000	6000
	Mechanical	Cycles		15000	15000	15000	15000	15000

Product Information

P630_TM Information

Frame / Model	Attribute	Unit	Condition	P630E_TM	P630F_TM	P630N_TM	P630H_TM	P630S_TM
Number of Poles				3, 4	3, 4	3, 4	3, 4	3, 4
Nominal current ratings Trip unit ratings	I_{CT}	(A)	30°C Calibration	630	630	630	630	630
Electrical characteristics								
Rated maximum operational voltage	U_e	(V)	AC 50/60 Hz	690	690	690	690	690
		(V)	DC	250	250	250	250	250
Rated insulation voltage	U_i	(V)		800	800	800	800	800
Rated impulse withstand voltage	U_{imp}	(kV)		8	8	8	8	8
Selectivity category				A	A	A	A	A
Rated short time withstand current	I_{cw}	(kA)	0.4 sec	—	—	—	—	—
Ultimate breaking capacity (IEC, JIS, AS/NZS)	I_{cu}	(kA)	690 Vac	—	7	12	12	12
			400 /415 Vac	25	36	50	70	110
			220 /240 Vac	35	50	85	100	125
DC Voltage			250 Vdc	25	25	50	50	50
Service breaking capacity (IEC, JIS, AS/NZS)	I_{cs}	(kA)	690 Vac	—	7	12	12	12
			400 /415 Vac	25	36	50	70	110
			220 /240 Vac	35	50	85	100	125
DC Voltage			250 Vdc	25	25	50	50	50
Protection - Over Current Release types	Std	Standard						
Fixed thermal magnetic	Opt	Optional		—	—	—	—	—
Adjustable thermal, adjustable magnetic	—	Not Available		Std	Std	Std	Std	Std
	M Req	Module Required						
Installation (Std / Opt / —)								
Front connection (FC)				Std	Std	Std	Std	Std
Extension bar (FB)				Opt	Opt	Opt	Opt	Opt
Cable tunnel clamp (FW)				Opt	Opt	Opt	Opt	Opt
Rear Connection (RC)				Opt	Opt	Opt	Opt	Opt
DIN rail adaptor				—	—	—	—	—
Withdrawable mechanism				Opt	Opt	Opt	Opt	Opt
Plug-in				Opt	Opt	Opt	Opt	Opt
Reverse supply connection possible to 440V				Yes	Yes	Yes	Yes	Yes
Dimensions								
	H	(mm)		260	260	260	260	260
	W	(mm)	1 pole	—	—	—	—	—
			2 pole	—	—	—	—	—
			3 pole	140	140	140	140	140
			4 pole	185	185	185	185	185
	D	(mm)		103	103	103	103	103
	T	(mm)		151	151	151	151	151
Weight								
	W	(kg)	1 pole	—	—	—	—	—
			2 pole	—	—	—	—	—
			3 pole	5.0	5.0	5.0	5.0	5.0
			4 pole	6.6	6.6	6.6	6.6	6.6
Operation options (Std / Opt / —)								
Toggle operation	Std	Standard		Std	Std	Std	Std	Std
Extension handle TP-HS/HP or Direct mount T2HB	Opt	Optional		Opt	Opt	Opt	Opt	Opt
Motor operation TP-MC	—	Not Available		Opt	Opt	Opt	Opt	Opt
Endurance								
	Electrical	Cycles	415 Vac	4000	4000	4000	4000	4000
	Mechanical	Cycles		15000	15000	15000	15000	15000

Internal Accessories

Internal accessories include Auxiliary and Alarm contacts, Shunt Trip and Undervoltage Trip (UVT) modules, which may be installed under the front cover of the MCCB in various combinations to provide additional functionality and connection with external control circuits.

Auxiliary & Alarm Switches

Auxiliary Contact

An auxiliary contact can be installed to indicate whether an MCCB is Open (both OFF and Tripped positions) or Closed (ON). Auxiliary contacts come in either general purpose or micro-switch type, with some combinations pre-wired or with terminals. Each contact type is provided as a single change-over switching arrangement (1x C/O).

Alarm Contact

An alarm contact can be installed to indicate whether an MCCB is in the Tripped or Not Tripped position (ON, OFF). Alarm contacts come in either general purpose or micro-switch type, with some combinations pre-wired or with terminals. Each contact type is provided as a single change-over switching arrangement (1x C/O).



Part Number	Description	Contact Type	Connection Type
T2AX00LML3SWA	Auxiliary	General purpose	Pre-wired
T2AX00LML3STA	Auxiliary	General purpose	Terminal
T2AX00LML3RWA	Auxiliary	Micro-switch	Pre-wired
T2AL00LML3SWA	Alarm; left side only	General purpose	Pre-wired
T2AL00LML3STA	Alarm; left side only	General purpose	Terminal
T2AL00LML3RWA	Alarm; left side only	Micro-switch	Pre-wired

General purpose contact						
AC (V)			DC (V)			Minimum Load
Volts (V)	Amperes (A)		Volts (V)	Amperes (A)		
	Resistive Load	Inductive Load		Resistive Load	Inductive Load	
480	—	—	250	—	—	100 mA @ 15 Vdc
250	3	2	125	0.4	0.05	
125	3	2	30	3	2	

Micro-switch contact		
DC (V)		Minimum Load
Volts (V)	Amperes (A)	
	Resistive Load	
30	0.1	1 mA @ 5 Vdc

Internal Accessories

Shunt Trip

A shunt (normally de-energized) can be installed to trip the MCCB by applying voltage to the shunt coil.



Part Number	Rated voltage		Connection Type
	AC (V)	DC (V)	
T2SH00LA10T	110	—	Terminal
T2SH00LA20T	230...240	—	Terminal
T2SH00LA40T	400...415	—	Terminal
T2SH00LD01T	—	12	Terminal
T2SH00LD02T	—	24	Terminal
T2SH00LD04T	—	48	Terminal
T2SH00LD10T	—	110	Terminal
T2SH00LD20T	—	230	Terminal
Pre-wired cage clamp			
T2SH00LA10WA	110	—	Pre-wired cage clamp
T2SH00LA20WA	230...240	—	Pre-wired cage clamp
T2SH00LA40WA	400...415	—	Pre-wired cage clamp
T2SH00LD01WA	—	12	Pre-wired cage clamp
T2SH00LD02WA	—	24	Pre-wired cage clamp
T2SH00LD04WA	—	48	Pre-wired cage clamp
T2SH00LD10WA	—	110	Pre-wired cage clamp
T2SH00LD20WA	—	230	Pre-wired cage clamp

Rated voltage	AC (V)			DC (V)				
	100...120	200...240	380...450	12	24	48	100...120	200...240
Excitation current (mA)	16.0	16.0	6.2	160.0	124.0	32.0	14.0	12.0

Under Voltage Trips

A UVT (normally energized) can be installed to trip the MCCB removing voltage from the UVT coil.



Part Number	Rated voltage		Compatible MCCB		Connection Type	Notes
	AC (V)	DC (V)	3P	4P		
T2UV00LA10NT	110	—	All	P160 / 250	Terminal	Instantaneous
T2UV00LA20NT	230...240	—	All	P160 / 250	Terminal	Instantaneous
T2UV00LA40NT	400...440	—	All	P160 / 250	Terminal	Instantaneous
T2UV00LD02NT	—	24	All	P160 / 250	Terminal	Instantaneous
T2UV00LD10NT	—	110	All	P160 / 250	Terminal	Instantaneous
T2UV00LD20NT	—	230	All	P160 / 250	Terminal	Instantaneous
Time Delay 500ms						
T2UV00LA10DS	110	—	All	P160 / 250	Terminal	Time Delay 500ms
T2UV00LA24DS	230...240	—	All	P160 / 250	Terminal	Time Delay 500ms
T2UV00LA45DS	440...450	—	All	P160 / 250	Terminal	Time Delay 500ms
T2UV00LD02DS	—	24	All	P160 / 250	Terminal	Time Delay 500ms
T2UV00LD10DS	—	110	All	P160 / 250	Terminal	Time Delay 500ms
T2UV00LD24DS	—	230	All	P160 / 250	Terminal	Time Delay 500ms
Time Delay 500ms						
T2UV00LA10DL	110	—	—	P400 / 630	Terminal	Time Delay 500ms
T2UV00LA24DL	230...240	—	—	P400 / 630	Terminal	Time Delay 500ms
T2UV00LA40DL	380...415	—	—	P400 / 630	Terminal	Time Delay 500ms
T2UV00LA45DL	440...450	—	—	P400 / 630	Terminal	Time Delay 500ms
T2UV00LD02DL	—	24	—	P400 / 630	Terminal	Time Delay 500ms
T2UV00LD10DL	—	110	—	P400 / 630	Terminal	Time Delay 500ms
T2UV00LD24DL	—	230	—	P400 / 630	Terminal	Time Delay 500ms
Pre-wired cage clamp						
T2UV00LA10NWA	110	—	All	P160 / 250	Pre-wired cage clamp	Instantaneous
T2UV00LA20NWA	230...240	—	All	P160 / 250	Pre-wired cage clamp	Instantaneous
T2UV00LA40NWA	440...450	—	All	P160 / 250	Pre-wired cage clamp	Instantaneous
T2UV00LD02NWA	—	24	All	P160 / 250	Pre-wired cage clamp	Instantaneous
T2UV00LD10NWA	—	110	All	P160 / 250	Pre-wired cage clamp	Instantaneous
T2UV00LD20NWA	—	230	All	P160 / 250	Pre-wired cage clamp	Instantaneous

Rated Voltage	AC (V)			DC (V)		
	100...120	200...240	380...450	24	100...120	200...240
Excitation current (mA)	1.3	1.1	2.0	22.0	9.0	3.7

Installation

Precautions



WARNING: To prevent electrical shock and damage to equipment, disconnect and isolate power source upstream of the MCCB before installing or servicing the MCCB including its connected accessories.



Notice: To ensure correct performance, and integrity of equipment, the installation instructions and recommendations provided herein shall be respected. Refer to the respective user manual and installation instructions provided with the MCCB and associated accessories.

Mounting Angles

TemBreak *PRO* MCCBs may be mounted at any angle without affecting performance.

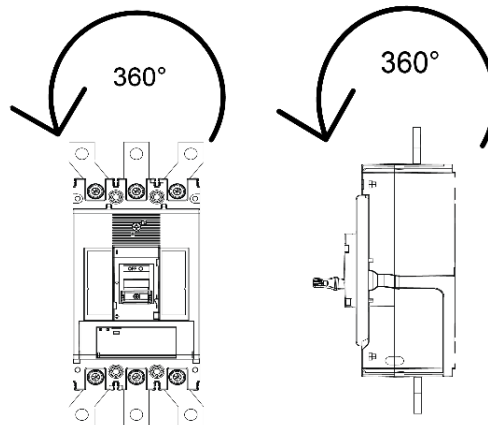

Direction of Power Supply

Power supply may be fed in either direction with respect to the MCCB without affecting performance.

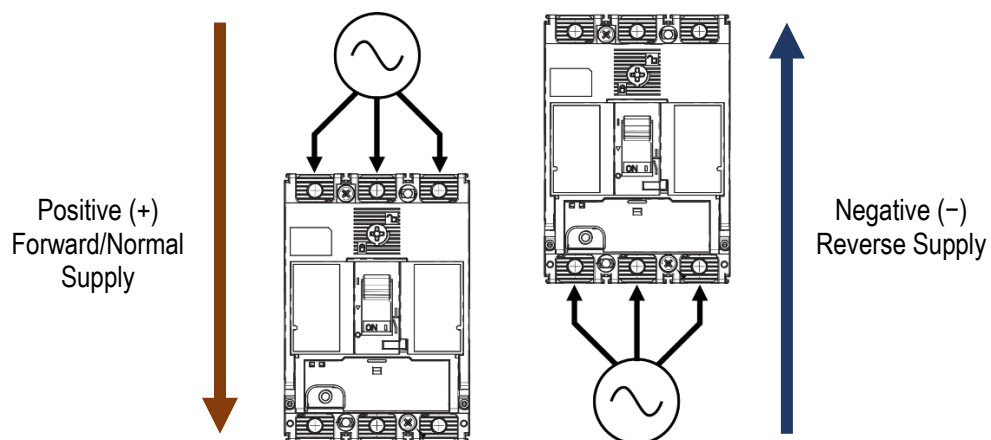

Installation

Clearances



WARNING: Exposed conductors including terminals at attached busbars must be insulated to avoid possible short-circuit or earth faults due any foreign matter coming into contact with the conductors.

Phase to Phase and Earth

Interruption of large currents during fault or normal switching operation produces ionised gases and arcing materials which expelled from the vents at the top of the MCCB for P160/P250, and top and bottom for P400/P630. These ionised gases are highly conductive, concentrated, and at an elevated temperature when it exits the MCCB via the arc vents. Care must be taken to avoid an arcing fault from occurring due to the presence of concentrated ionised gases creating a conductive path between exposed conductors. Incoming conductors must therefore be insulated the full length up to the terminal opening of the MCCB, ensuring bare conductors are not exposed directly to concentrated ionised gases. This also applies to the attached busbars supplied as part of the MCCB.

Interpole barriers or terminal covers may be used to achieve creepage and clearance requirements. Conductors must not impede the flow of ionised gas and allow it to clear and disperse safely. Interpole barriers are supplied as standard with Terasaki MCCBs for the line side only. 2 barriers with 3P MCCBs and 3 with 4P MCCBs. In cases where two different MCCB types are installed one above the other, the insulation distance between the two models should be as for the lower model.

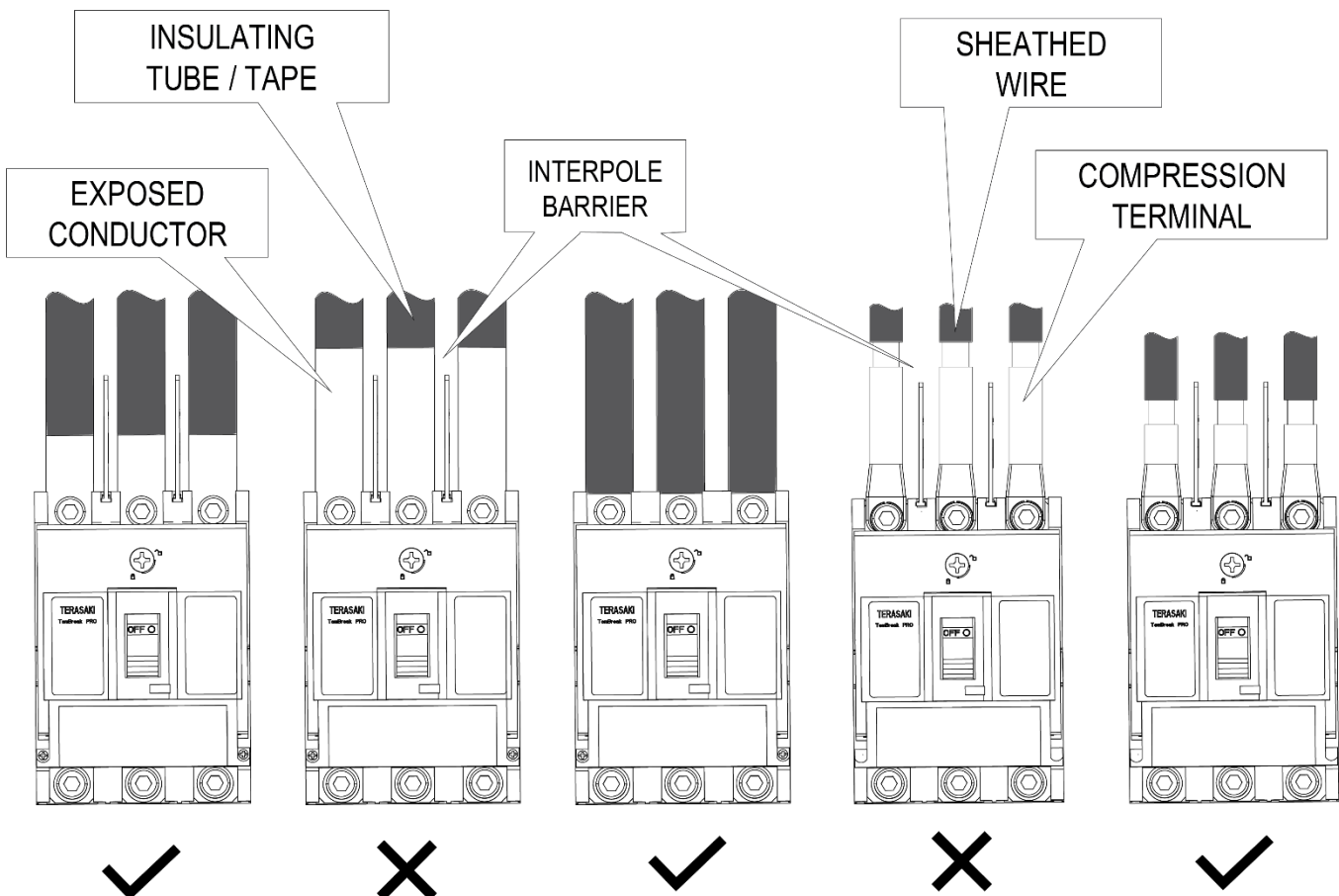

Installation

Insulating Distance

When earth metal is installed within proximity of the breakers, the correct insulating distance must be maintained, (refer to Minimum Clearance). This distance is necessary to allow the exhausted arc gases to disperse. This could include the mounting plate or side panel within a switchboard.

Minimum Clearance

Below illustrates the minimum clearance that must be maintained.

Dim.	Description
A	Distance from lower breaker to open charging part of terminal on upper breaker (front connection) or the distance from lower breaker to upper breaker end (rear connection and plug-in type)
B ₁	Distance from breaker end to ceiling (earthed metal)
B ₂	Distance from breaker end to insulator
C	Clearance between breakers
D	Distance from breaker side to side plate (earthed metal)
E	Length of insulation over exposed conductors.

MCCB Cat. No.	Distances (mm)					
	A	B ₁	B ₂	C	D	E
P160F	50	10	10	0	25	^
P160N / H / D	75	45	25	0	25	^
P250F	50	40	30	0	25	^
P250N / H / D	80	80	30	0	25	^
P400E / F / N / H / D	100	80	60	0	80	^
P400S	120	120	80	0	80	^
P630E / F / N / H / D	100	80	60	0	80	^
P630S	120	120	80	0	80	^

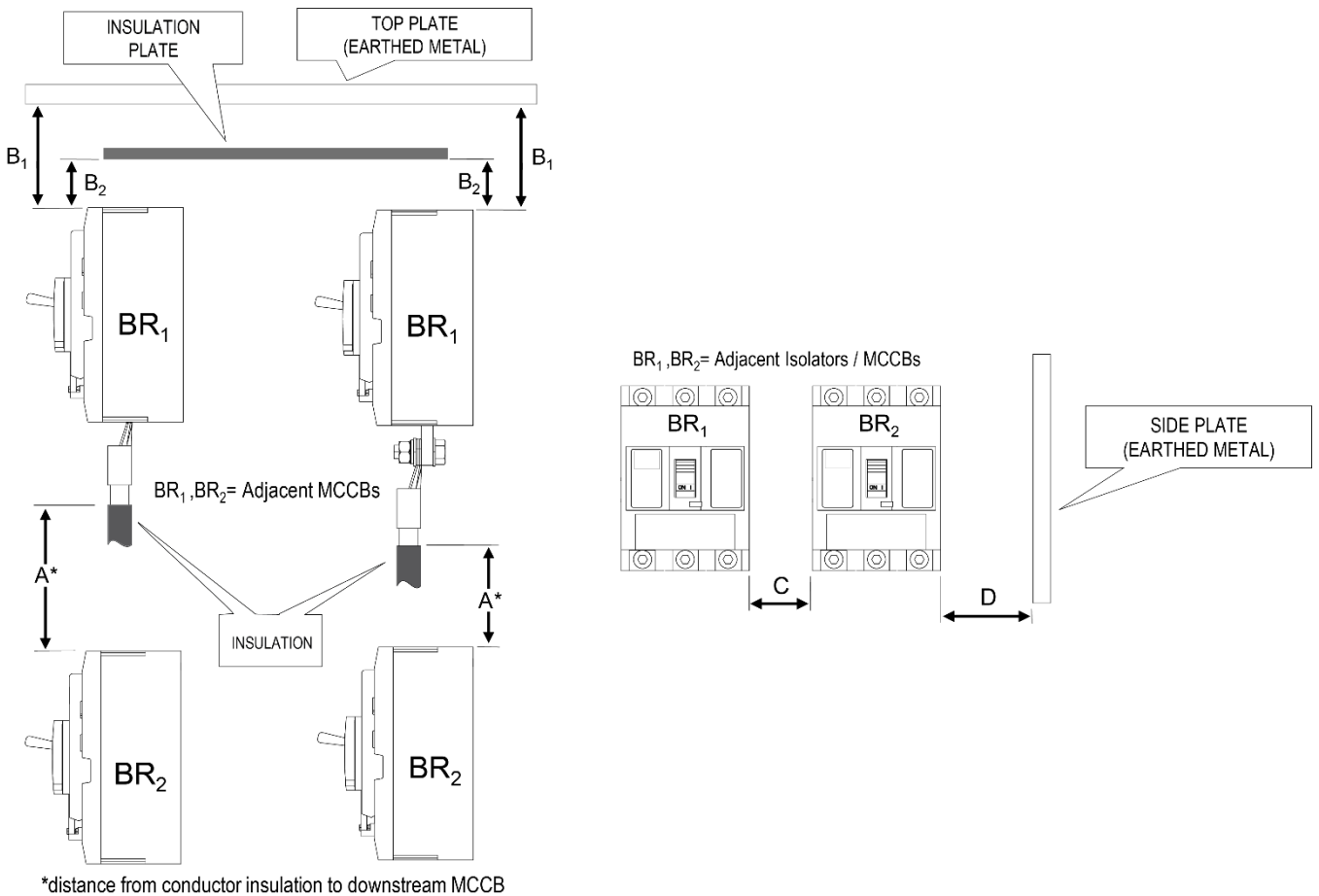

^ Insulate the exposed conductor until it overlaps the moulded case at the terminal, or the terminal cover.

Installation

Internal Accessory Mounting Locations

P160, P250 and P400/630 frame sizes have different internal mounting locations for auxiliary contacts, alarm contacts, shunts and, UVTs.

Left-side and right-side mounting locations are independent and accept unique combinations. For example, shunts and UVTs may only be mounted on the right side, whereas auxiliary and alarm contacts may be mounted on either left or right side.

Refer to the following illustrations for each frame size listing the various possible internal accessories combinations.

P160 internal accessories combination

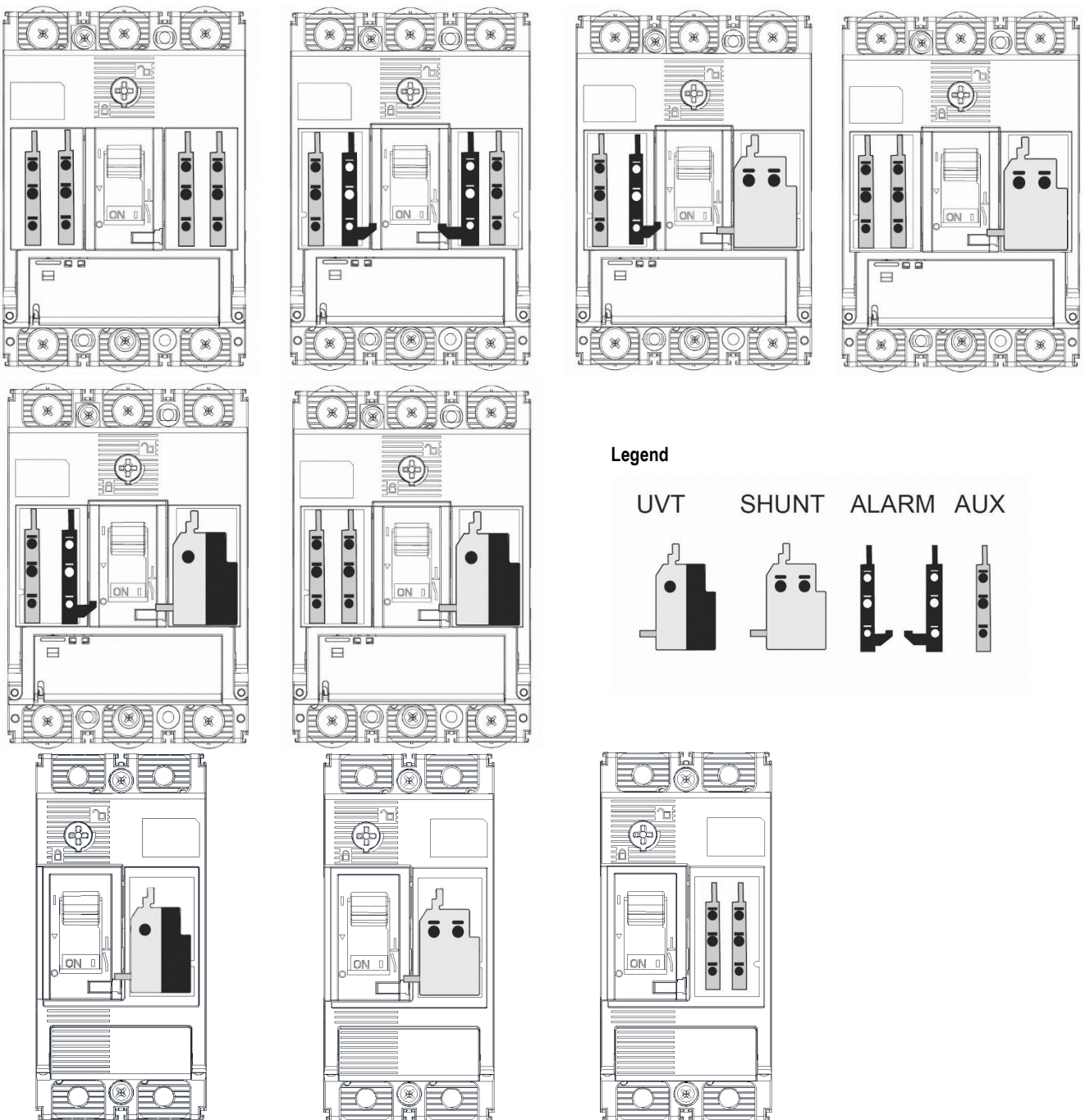

Installation

P250 internal accessories combination

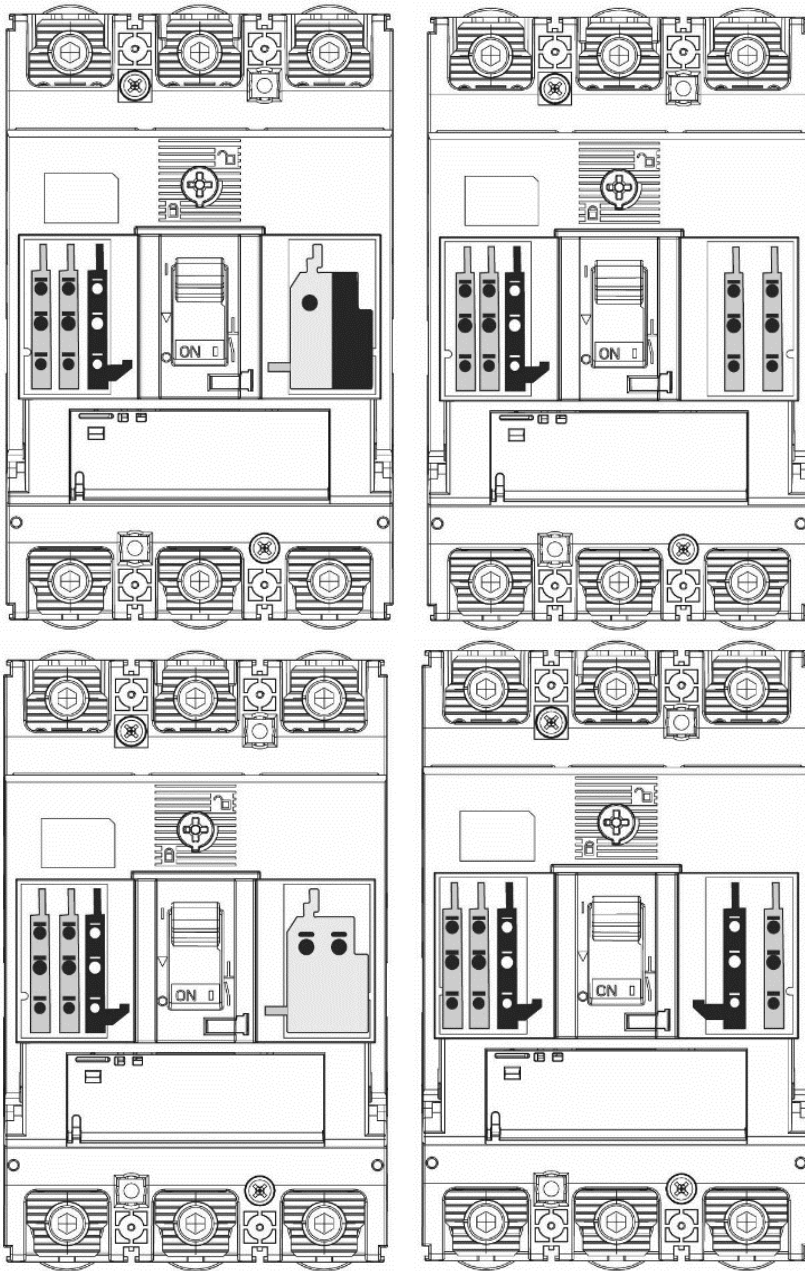

Legend

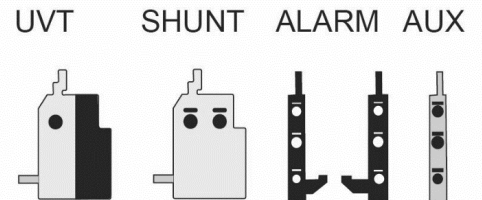

Installation

P400/630 internal accessories combination

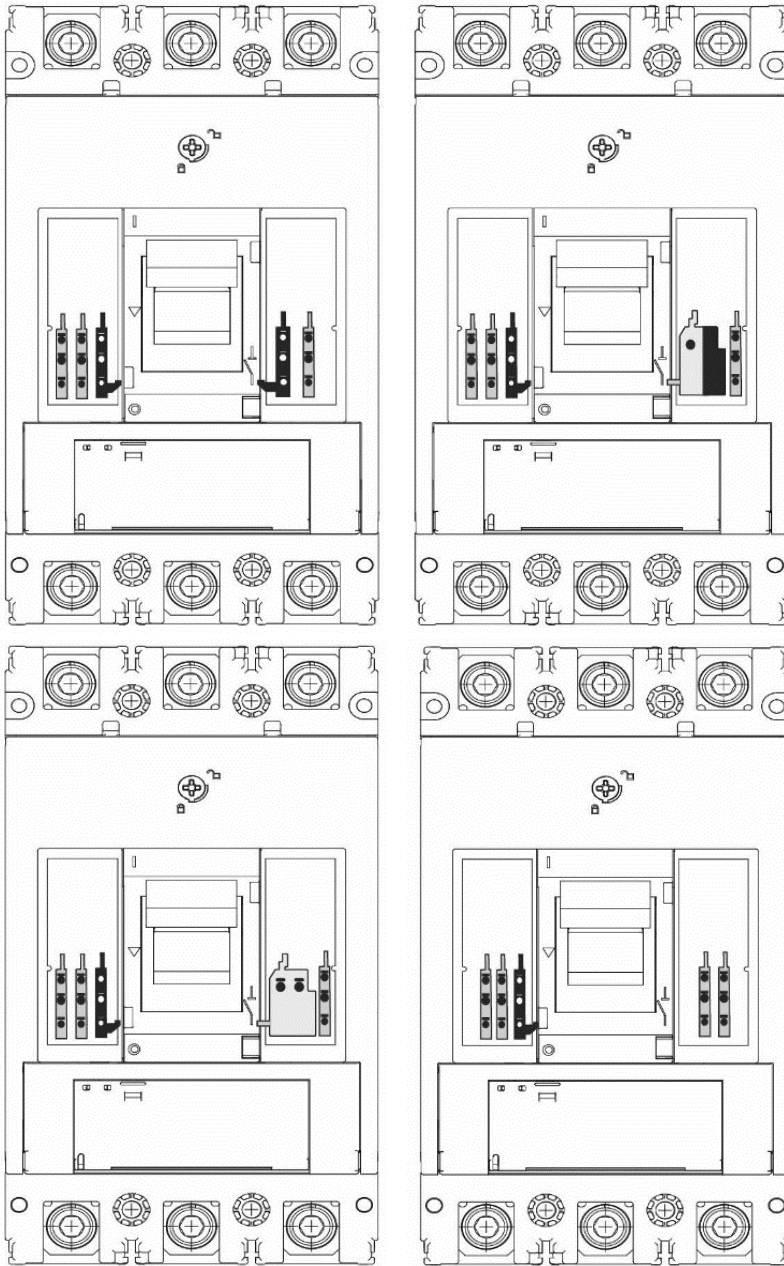

Legend

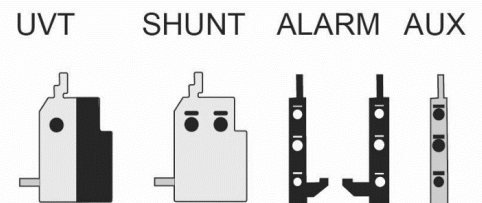

Notice: Only 2 internal accessories can be mounted on the right-hand side of a P400 and P630 MCCB. Under no circumstances can 3 or more be installed.

Examples:

- 2 AUX
- 1 Alarm and 1 AUX
- 1 Shunt and 1 AUX
- 1 UVT and 1 AUX

Installation

Alarm, Shunt & UVT Installation

The alarm, shunt and UVT have a trip bar that needs to interact with the MCCBs trip mechanism. As such they must be installed in a specific way. Refer to the supplied Installation Instructions for the respective accessories for further detail.

Standard Alarm & Auxiliary installation

Action	Note
1 Switch the Smart MCCB to the Tripped Position.	
2 Open the front cover of the MCCB.	
3 Locate the alarm's trip bar into the MCCB trip mechanism slot.	
4 The alarm will need to be rolled into place, follow the images to the right.	
5 Run the wires out the left-hand side of the MCCB, through the allocated groves.	

Shunt & UVT installation

Action	Note
1 Switch the Smart MCCB to the Tripped Position.	
2 Open the front cover of the MCCB.	
3 Locate the shunt or UVT's trip bar into the MCCB trip mechanism slot.	
4 The shunt or UVT will need to be rolled into place, follow the images to the right.	
5 Run the wires out the right-hand side of the MCCB, through the allocated groves.	

Protection Settings

Trip Curve

The TemBreak *PRO* P_TM thermal magnetic trip unit protects against overcurrent and short circuit faults for many types of electrical distribution systems. The P_TM OCR has protective characteristics according to the requirements of the standard AS/NZS IEC 60947-2.

The P_TM OCR consists of a standard 2 dial type (blue coloured dials) which features thermal adjustment and magnetic adjustment. 4P MCCBs also feature a third dial for neutral protection adjustment.

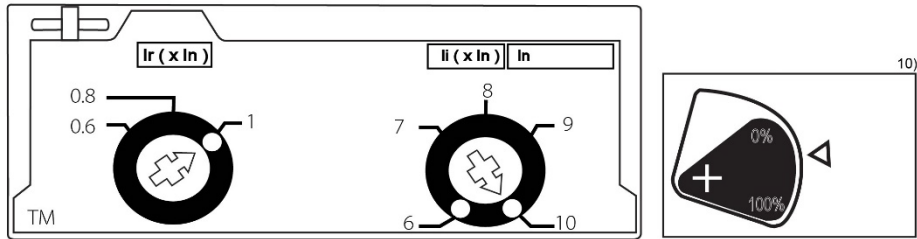

List of Protection Functions

Abbreviation	Description	Protection against	Symbol	Definition
T	Thermal	Low level current overload	I _r	Threshold thermal protection
M	Magnetic	High level current short-circuit	I _i	Threshold magnetic protection

Time-current curve

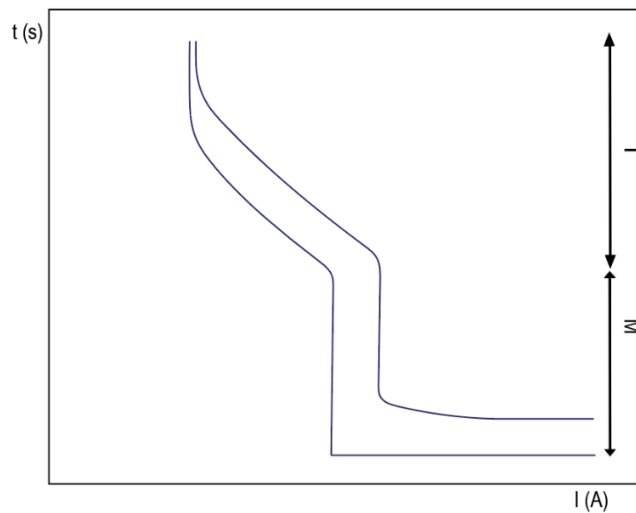

Protection Settings

Thermal protection

The thermal protection is designed to protect against current overloads or surges in power distribution or motor control applications. Thermal protection is an inverse-time protection, labeled as I_r .

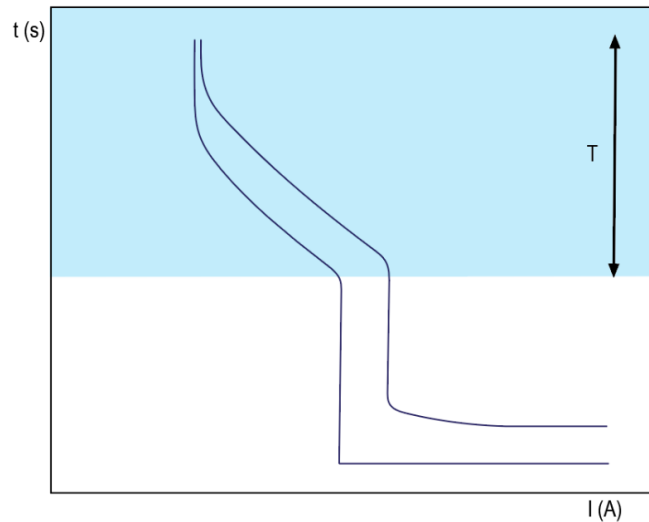

TM – Adjusting I_r (Current)

The thermal protection trip range is: $0.63 - 1.0 \times I_n$ according to standard AS / NZS / IEC 60947-2. The thermal protection is calibrated to 50°C , with the exception of the P630 frame which is calibrated to 30°C .

The I_r trip threshold is adjusted using the I_r dial on the front of the MCCB: It is continuously adjustable between $0.63 \times I_n$ to $1.0 \times I_n$, with reference labels of 0.63, 0.8 and 1.0 on the I_r dial.

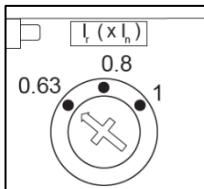

Thermal Protection Settings (I_r)		
Rating (I_n)	Dial Range ($\times I_n$)	Adjustable Current Range (A)
20 A	0.63 ... 1.0	12.5 ... 20
32 A	0.63 ... 1.0	20 ... 32
50 A	0.63 ... 1.0	32 ... 50
63 A	0.80* ... 1.0	50 ... 63
100 A	0.63 ... 1.0	63 ... 100
125 A	0.63 ... 1.0	80 ... 125
160 A	0.63 ... 1.0	100 ... 160
200 A	0.63 ... 1.0	125 ... 200
250 A	0.63 ... 1.0	160 ... 250
400 A	0.63 ... 1.0	250 ... 400
630 A	0.63 ... 1.0	400 ... 630



Notice: P630_TM MCCB thermal protection is calibrated to 30°C



Notice: The adjustable range of P160_63TM is 0.8 – 1.0

Protection Settings

Thermal protection

FF – Fixed I_r (Current)

The thermal protection of the FF type OCR is fixed to the rated current of the MCCB (I_n). The options for the various MCCB rated currents and the associated thermal trip threshold currents are as follows:

Thermal Protection Settings (I_r)	
Rated (I_n)	Thermal trip threshold (I_r)
15 A	15 A
20 A	20 A
30 A	30 A
40 A	40 A
50 A	50 A
60 A	60 A
75 A	75 A
100 A	100 A
125 A	125 A

Labelling of Calibrated Points

I_r dial of the MCCB has been calibrated for points 0.63, 0.8 & 1 x I_n .

I_r calibration points are marked as follows:

Red: 1.0 x I_n

Blue: 0.8 x I_n

Black: 0.63 x I_n



WARNING: Setting I_r dial outside of the calibrated zone (0.63 - 1) may cause unpredictable behaviour of the MCCB.

Protection Settings

Magnetic Protection

The magnetic protection is designed to protect against fast high current faults such as short circuits, labeled as I_i . P_TM MCCBs are available in magnetic only for instantaneous trip exclusively.

I_i has incremental adjustments dependent on frame size and I_n .

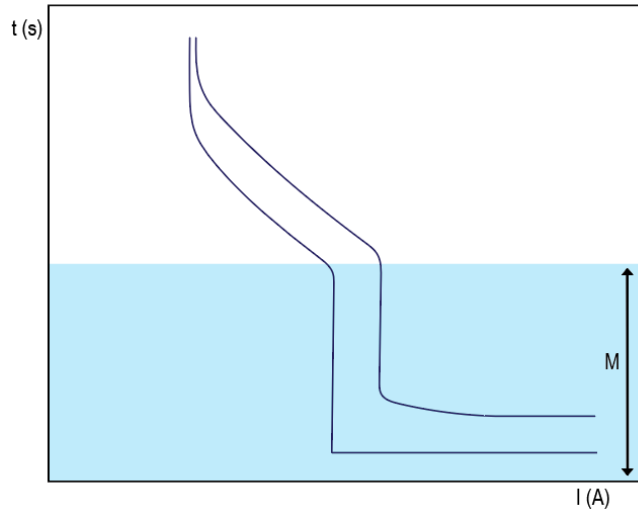

TM – Adjusting I_i (Current)

I_i is the magnetic element adjustment dial and is used to set the short circuit tripping threshold to suit the application. I_i adjustments are performed of set increments, such as those shown represented for example: 6 – 8 – 10 – 13 x I_n .

The I_i trip threshold is adjusted using the I_i dial on the front of the MCCB: It is adjustable in set increments as multiples of I_n . For example, 6 – 7 – 8 – 9 – 10 x I_n .

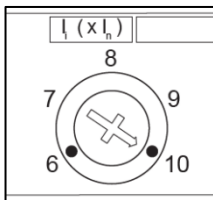

Notice: Only calibrated multiple increments are labelled on the I_i dial. Dial positions between these labelled positions are not defined.

Example: dial position between 8 and 9. The I_i threshold current is set to a value which is greater than 8 x I_n and less than 9 x I_n , but does not have a defined I_i value.

Protection Settings

Magnetic Protection

FF – Fixed I_i (Current)

The magnetic protection of the FF type OCR is fixed to a multiple the rated current of the MCCB (I_n) where $I_i = 12 \times I_n$. The options for the various MCCB rated currents and the associated magnetic trip threshold currents are as follows:

Magnetic Protection Settings (I_i)	
Rated (I_n)	Magnetic trip threshold (I_i)
15 A	180 A
20 A	240 A
30 A	360 A
40 A	480 A
50 A	600 A
60 A	720 A
75 A	900 A
100 A	1200 A
125 A	1500 A

Protection Settings

Magnetic Protection

Adjusting I_i (Current)

Multiple increments shown on the label differ depending on the MCCB frame size and OCR rating. The below tables provide the available increments which may be set per MCCB and OCR combination, and the resulting I_i current threshold.

Magnetic Protection (I_i) settings			
MCCB	Rating (I_n)	Dial position ($\times I_n$)	I_i current (A)
P160	20 A	6 – 8 – 10 – 12	120 – 160 – 200 – 240
	32 A	6 – 8 – 10 – 12	196 – 256 – 320 – 384
	50 A	6 – 8 – 10 – 12	300 – 400 – 500 – 600
	63 A	6 – 8 – 10 – 12	378 – 504 – 630 – 756
	100 A	6 – 8 – 10 – 12	600 – 800 – 1000 – 1200
	125 A	6 – 8 – 10 – 12	750 – 1000 – 1250 – 1500
	160 A	6 – 7 – 8 – 9 – 10	960 – 1120 – 1280 – 1440 – 1600
P250	50 A	6 – 8 – 10 – 13	300 – 400 – 500 – 650
	63 A	6 – 8 – 10 – 13	378 – 504 – 630 – 819
	100 A	6 – 8 – 10 – 13	600 – 800 – 1000 – 1300
	125 A	6 – 8 – 10 – 13	750 – 1000 – 1250 – 1625
	160 A	6 – 8 – 10 – 13	960 – 1280 – 1600 – 2080
	200 A	6 – 8 – 10 – 12	1200 – 1600 – 2000 – 2400
	250 A	6 – 7 – 8 – 9 – 10	1500 – 1750 – 2000 – 2250 – 2500
P400	250 A	5 – 6 – 7 – 8 – 9 – 10	1250 – 1500 – 1750 – 2000 – 2250 – 2500
	400 A	5 – 6 – 7 – 8 – 9 – 10	2000 – 2400 – 2800 – 3200 – 3600 – 4000
P630	630 A	4 – 5 – 6 – 7 – 8	2520 – 3150 – 3780 – 4410 – 5040

Protection Settings

Neutral Protection

Neutral protection is available with 4P P_TM MCCBs as standard. It is particularly useful when the cross-section of the neutral conductor is reduced in relation to the phase conductors.

When enabled via the provided selector switch, neutral protection provides both thermal and magnetic protection of the Neutral pole, which follows the parameters I_r and I_i as adjusted for the main phases.

When disabled, only thermal protection of the Neutral pole is disabled. Magnetic protection of the Neutral pole is always enabled, regardless of the position of the selector switch.

	Neutral Protection selector position	
	OFF	ON
Thermal protection	$I_N = \text{disabled}$	$I_N = I_r$
Magnetic protection	I_i	I_i

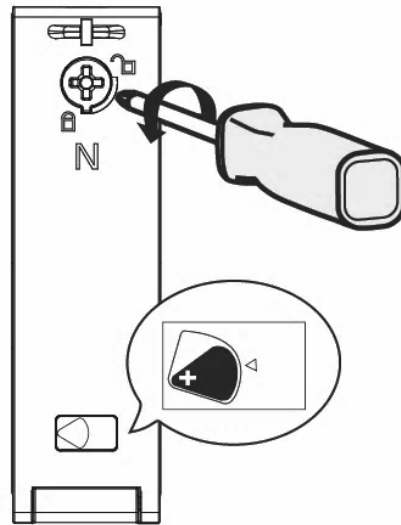

Protection Settings

Temperature Ratings

The P_TM MCCB is fitted with a thermomagnetic trip unit which has its thermal element set for a specific calibration temperature. The P_TM MCCBs have been calibrated for operation at 50°C for all frame sizes except for the P630_TM which is calibrated to 30°C.



Notice: Due to the nature of thermal protection, it is not possible to set I_r to an exact value. Ambient temperatures and conductor temperatures will have an effect. The P_TM MCCBs have been calibrated for operation at 50°C.
Exception P630_TM calibrated to 30°C

For ambient temperatures other than 50°C, with the maximum setting, the variation of thermal current threshold is given in the tables as follows:

Refer to [Annex F – Temperature Calibration Tables](#) for details on temperature deratings.

Commissioning

Thermal Setting (I_r)



WARNING: Risk of nuisance tripping.
Only qualified personnel are to set the protection levels. Failure to respect these instructions may cause death, serious injuries or equipment damage.



WARNING: Setting I_r dial outside of the calibrated zone (0.63 - 1) may cause unpredictable behaviour of the MCCB.

Action	Note / Illustration
<p>1 Switch the MCCB to the OFF Position. Open the transparent flap in order to access the max I_r adjustment dial.</p>	
<p>2 Using a PH1, PH2 or PZ2 size screwdriver, rotate the I_r adjustment dial to the desired value of I_r in Amperes.</p> <p>I_r calibration points are marked as follows: Red: $1.0 \times I_n$ Blue: $0.8 \times I_n$ Black: $0.63 \times I_n$</p>	<p>Note: The adjustments for I_r are continuous and not discrete.</p>



Notice: Due to the nature of thermal protection, it is not possible to set I_r to an exact value. Ambient temperatures and conductor temperatures will have an effect. The P_TM MCCBs have been calibrated for operation at 50°C.
Exception P630_TM calibrated to 30°C

Commissioning

Magnetic Setting (I_i)



WARNING: Risk of nuisance tripping.
Only qualified personnel are to set the protection levels. Failure to respect these instructions may cause death, serious injuries or equipment damage.

Action	Note / Illustration
<p>Switch the MCCB to the OFF Position.</p> <p>1 Open the transparent flap in order to access the max I_i adjustment dial</p>	
<p>Using a PH1, PH2 or PZ2 size screwdriver,</p> <p>2 rotate the I_i adjustment dial to the required multiple of I_n.</p>	
	<p>Note: The adjustments for I_i are discrete settings based on the frame size and I_n of the MCCB. Refer to the available settings in Protection Settings – Magnetic Protection section.</p>

Commissioning

Neutral Protection Setting (N)

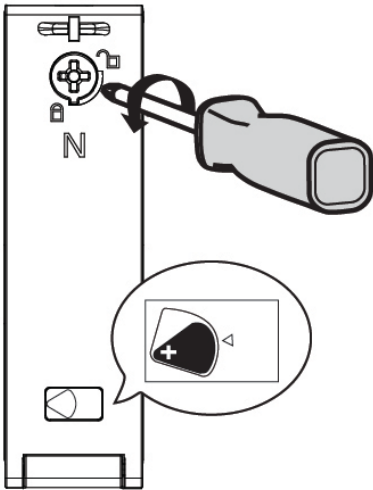
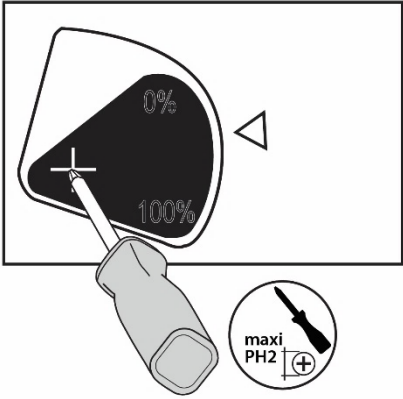

WARNING: Risk of nuisance tripping.
Only qualified personnel are to set the protection levels. Failure to respect these instructions may cause death, serious injuries or equipment damage.

Action	Note / Illustration
<p>1</p> <p>Switch the MCCB to the OFF Position. Open the transparent flap in order to access the 4th Pole Neutral adjustment dial.</p>	
<p>2</p> <p>Using a PH1, PH2 or PZ2 size screwdriver, rotate the Neutral protection adjustment dial to 0% or 100%. 0% = OFF 100% = ON</p>	 <p>Note: N-pole instantaneous (Ii) tripping will remain ON at all times.</p>

Troubleshooting

In the event of a problem when using the TemBreak *PRO* system, this section provides advice on how to resolve issues.

	Problem description	Possible cause	Remedial advice
1	Abnormal voltage on load side	Excessive wear of contacts	Replace MCCB.
		Foreign matter interfering with contacts or contact surfaces	
2	Failure in ON position	Reset operation not conducted after tripping operation.	Perform reset operation.
3	Failure in RESET position	UVT not energised	Apply voltage to UVT
		Circuit breaker service life ended due to large number of switching cycles using SHT or UVT	Replace MCCB
		Fault of tripping mechanism	
4	Nuisance tripping while rated current not reached	Vibration and/or shock	Dampen vibration of MCCB and review installation requirements
		High proportion of high frequency distortion in load current.	Decrease distortion content of load circuit
		Electromagnetic induced interference (from nearby conductors or external radio sources)	Review nearby sources of conducted and radiated emissions (e.g. radio sources, high-speed switching devices including variable frequency drives)
		Excessive surge	Isolate and mitigate surge source (e.g. surge protection devices)
		Erroneous connection of control circuit for SHT or UVT	Verify control wiring and supply to SHT and UVT
5	Nuisance tripping due to starting current	Excessive inrush starting current due to load type	Review INST and STD protection settings for load type where applicable
		Switching operation of star-delta motor starter, incorrect wiring	Verify and correct any issues with star-delta starter wiring with respect to the motor windings and phase sequence. Refer to motor and/or starter manufacturer
		Short-circuit in motor (e.g. windings, starter circuit)	Verify and correct any issues with motor wiring. Inspect and verify motor winding insulation. Refer to motor manufacturer
		Erroneous connection of control circuit for SHT or UVT	Verify control wiring and supply to SHT and UVT
6	No trip at pickup current	Failure in selectivity/coordination with upstream circuit breaker or fuse	Review selectivity/coordination study and protection parameters of each device
		Incorrect protection settings	Review enabled protection settings ensuring correct pickup current and time-delay for load type. (e.g. LTD, STD, INST pickup currents and time delays)

Annex A – Dimensions

P160 Dimensions

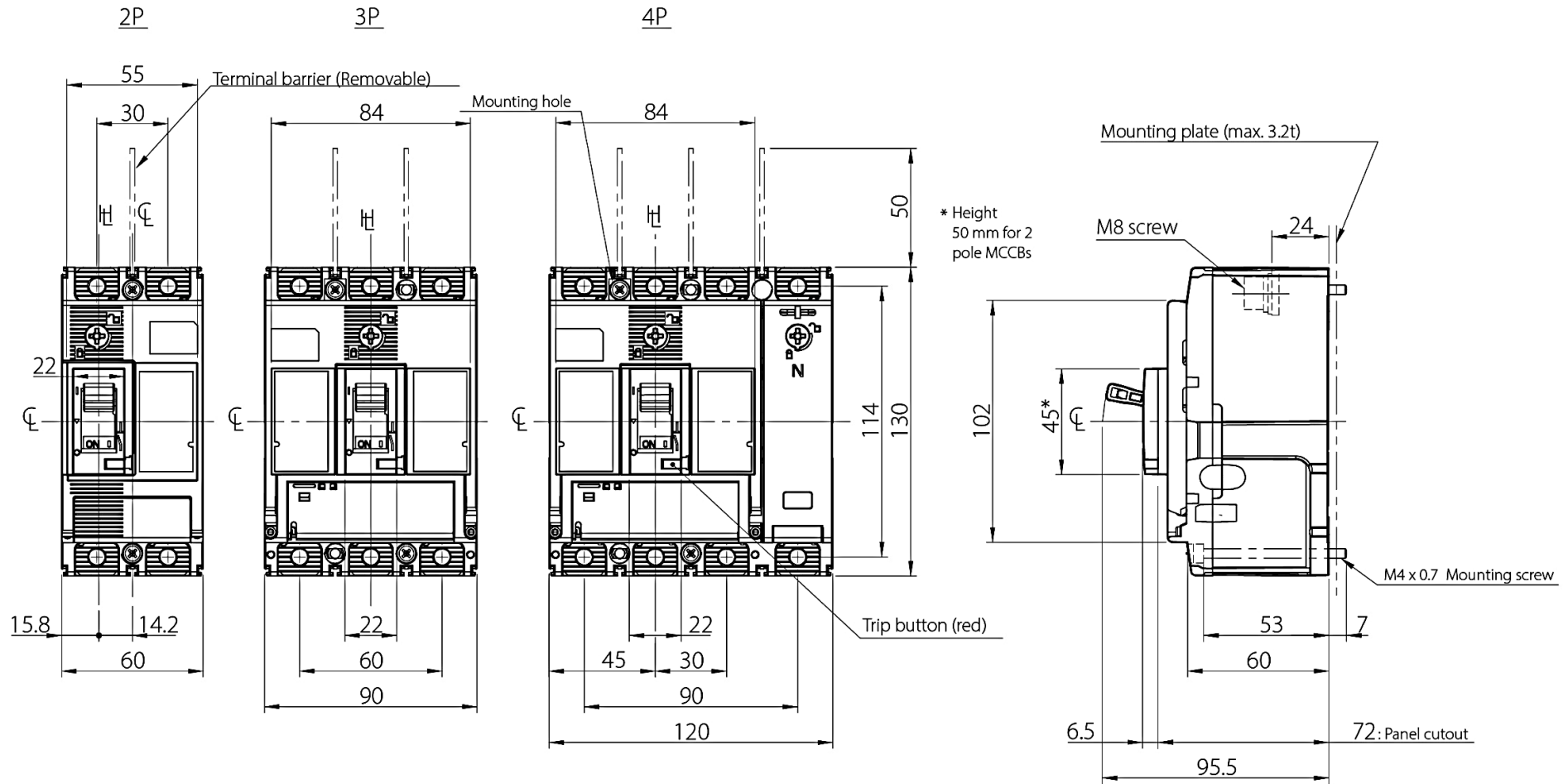

Annex A – Dimensions

P250 Dimensions

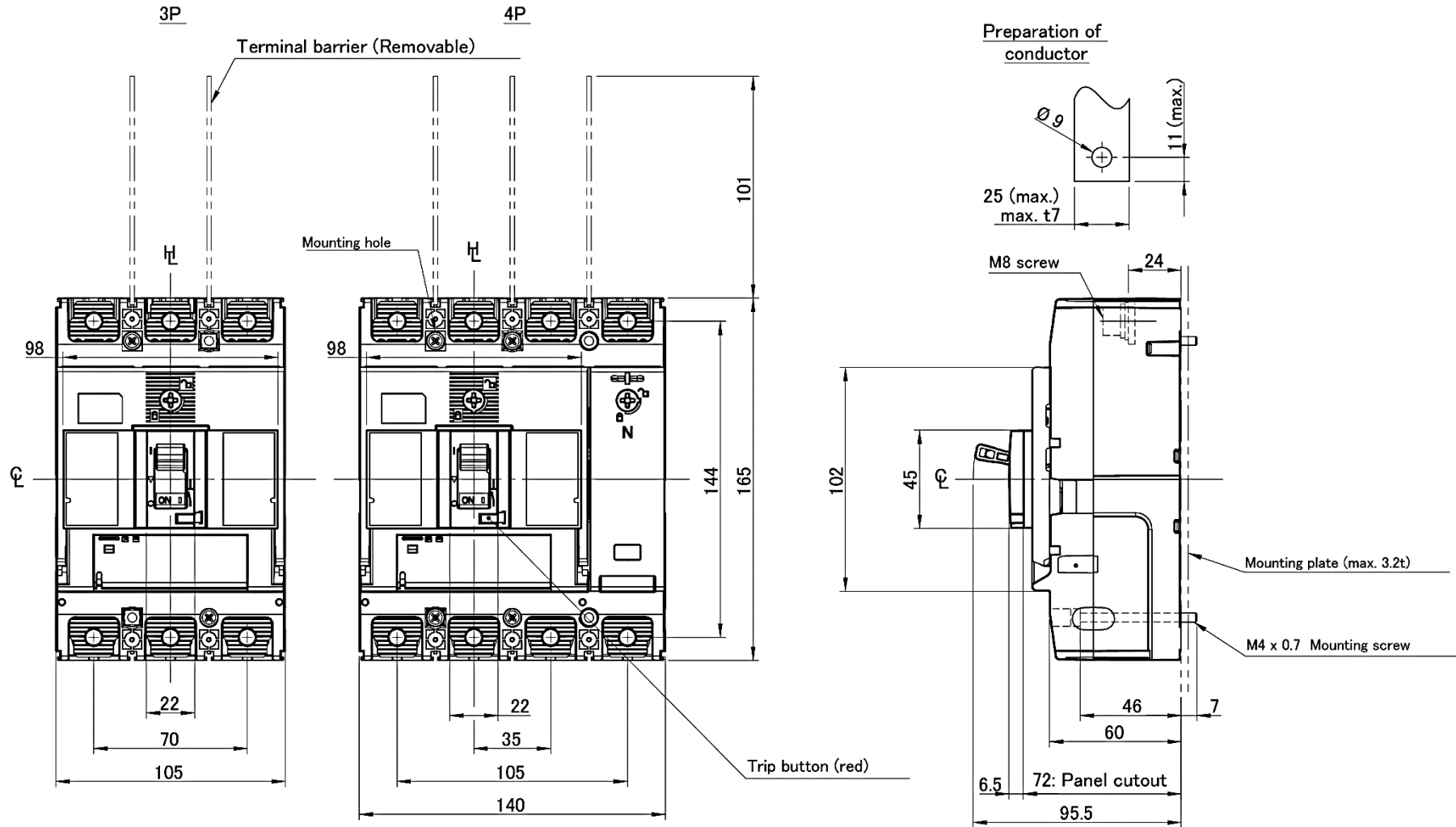

Annex A – Dimensions

P400 Dimensions

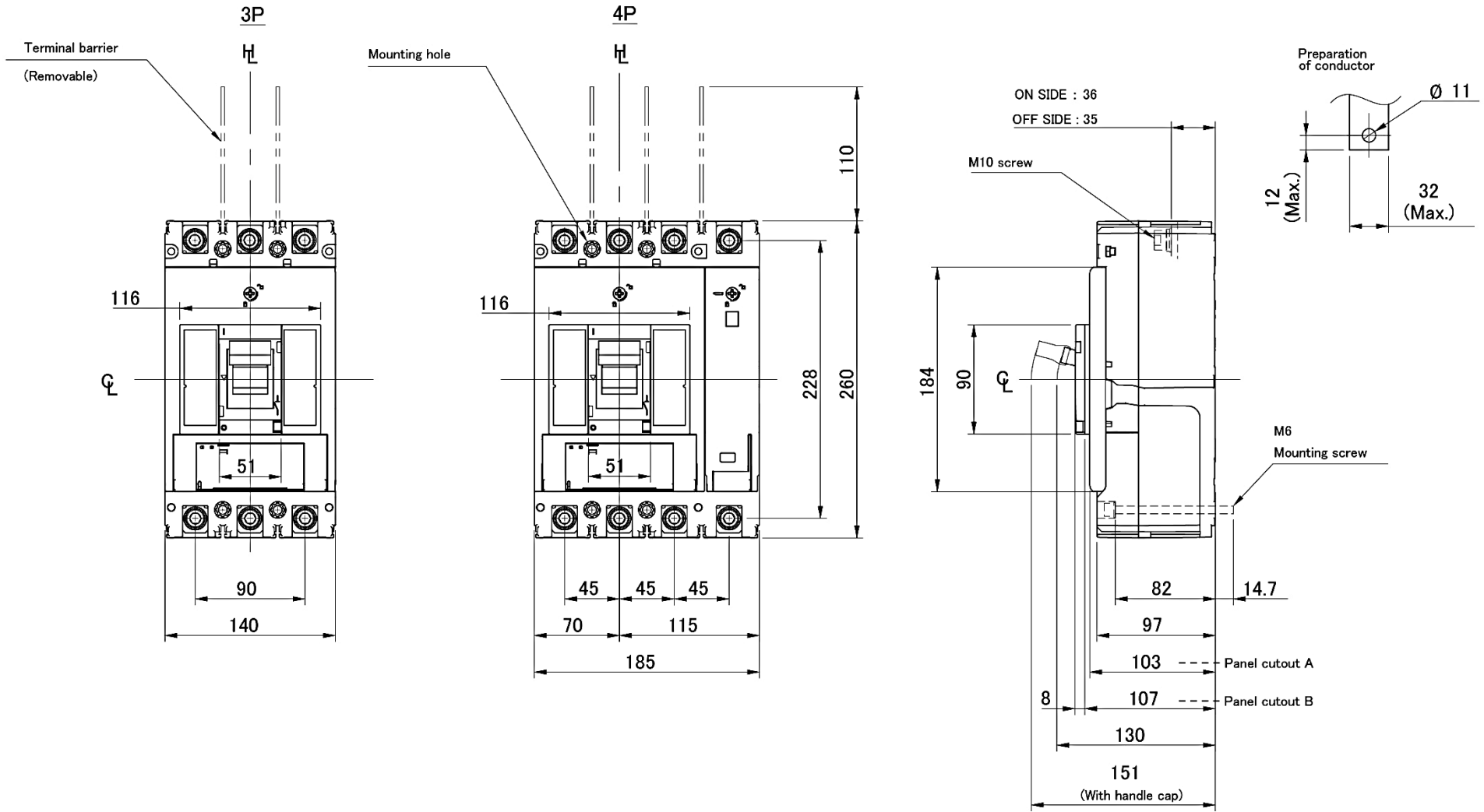

Annex A – Dimensions

P630 Dimensions

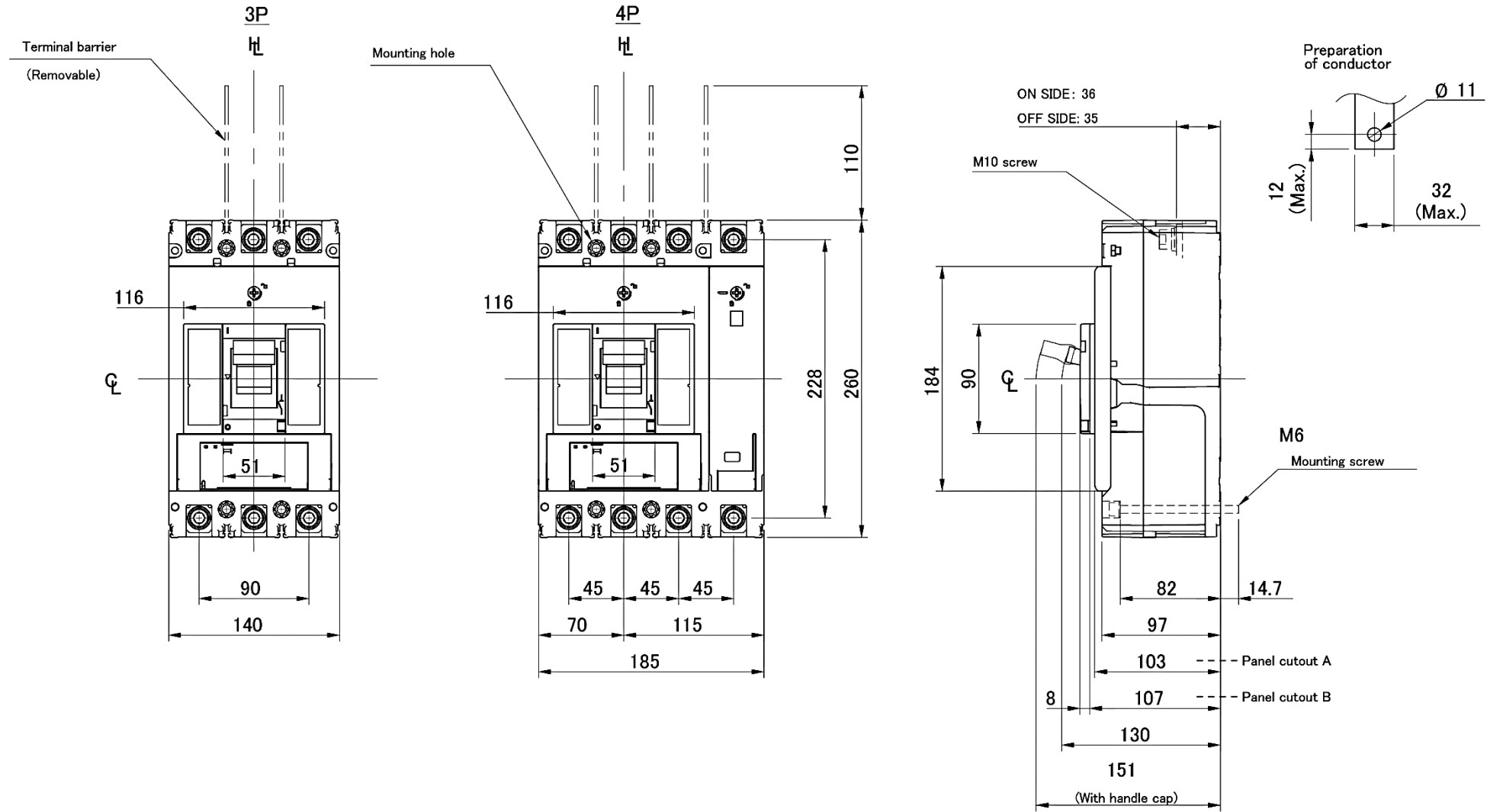

Annex B – Trip Curves

P160F / N / H

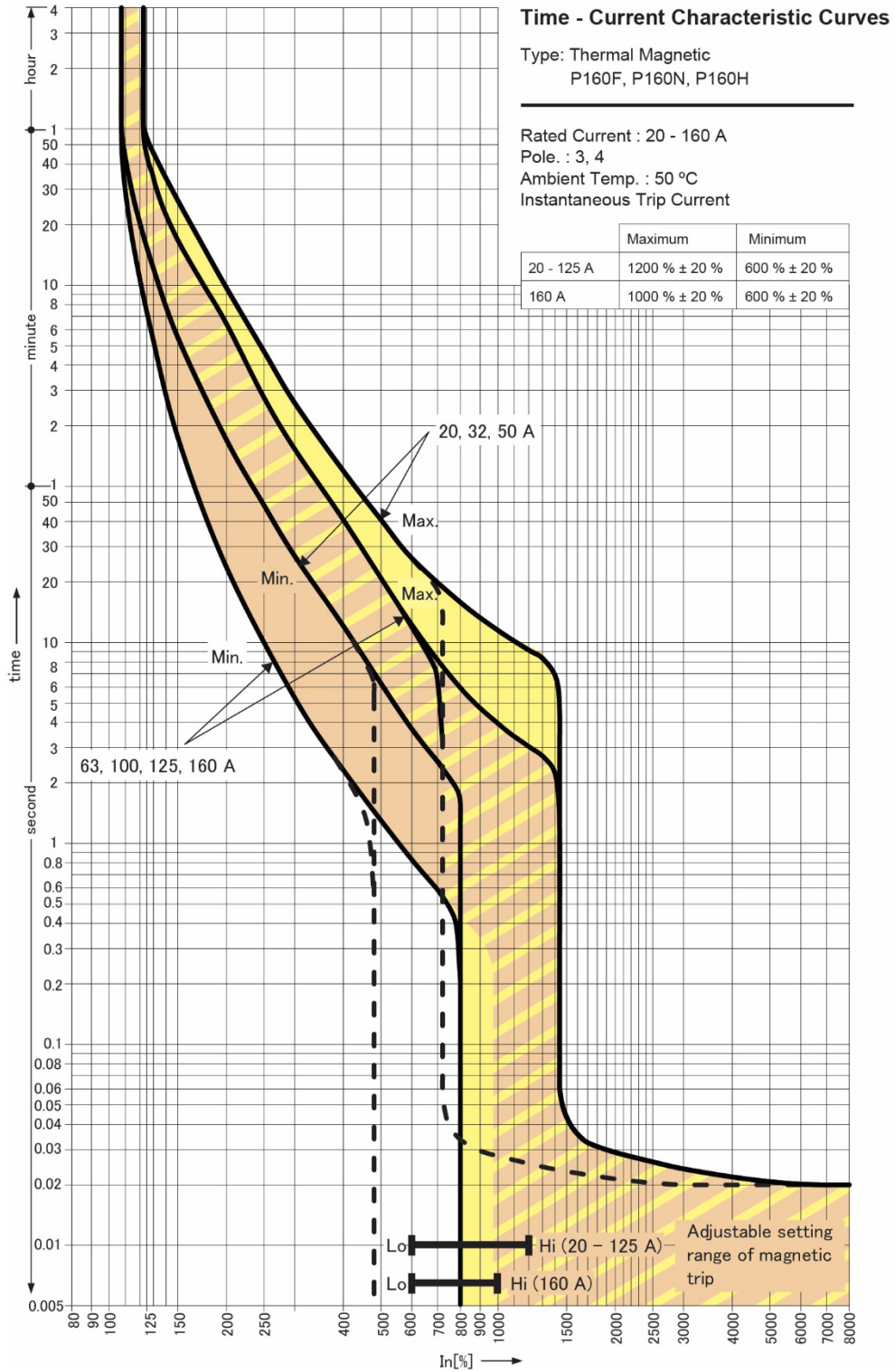

Annex B – Trip Curves

P250F / N / H

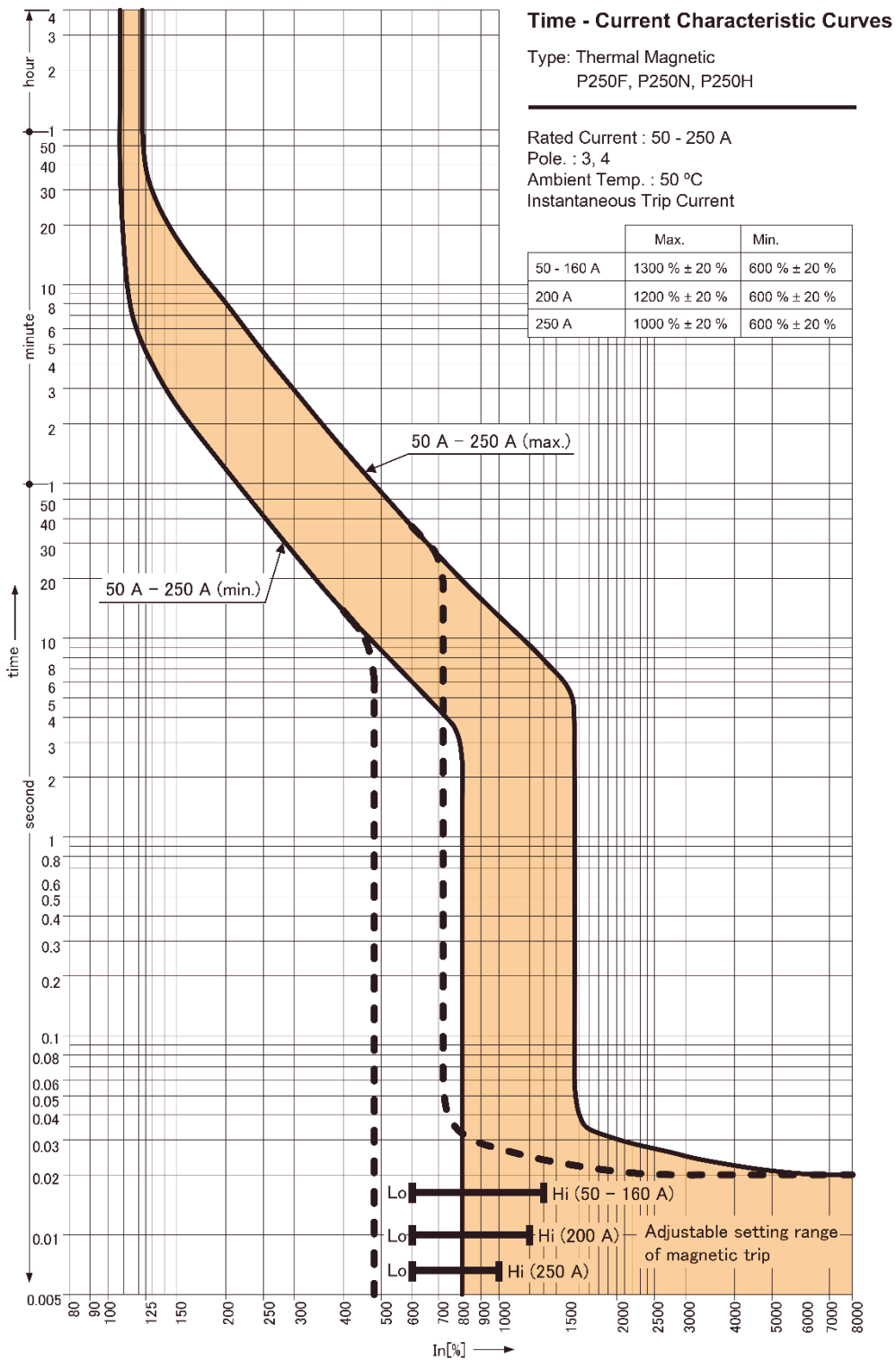

Annex B – Trip Curves

P400E / F / N / H / S

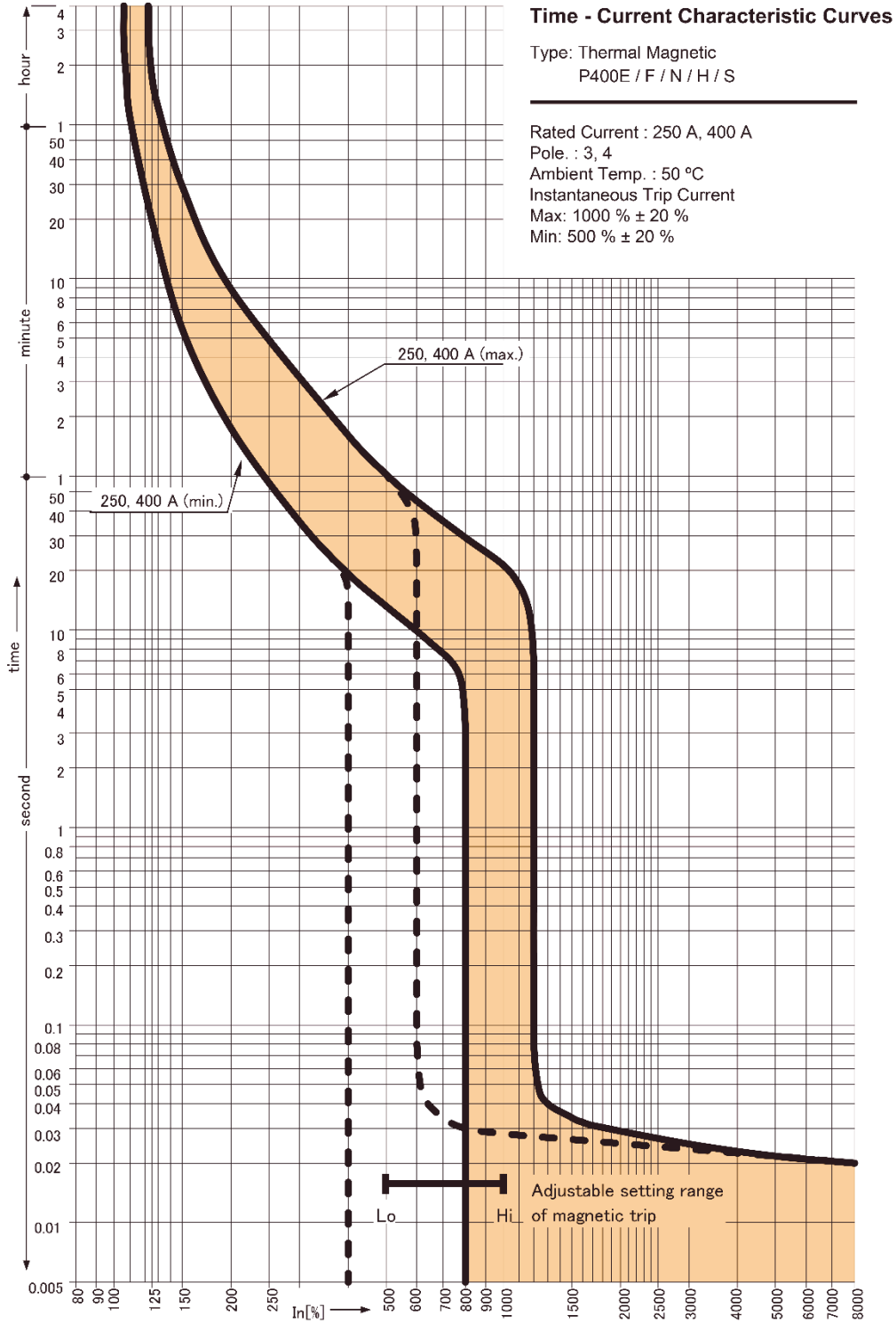

Annex B – Trip Curves

P630E / F / N / H / S

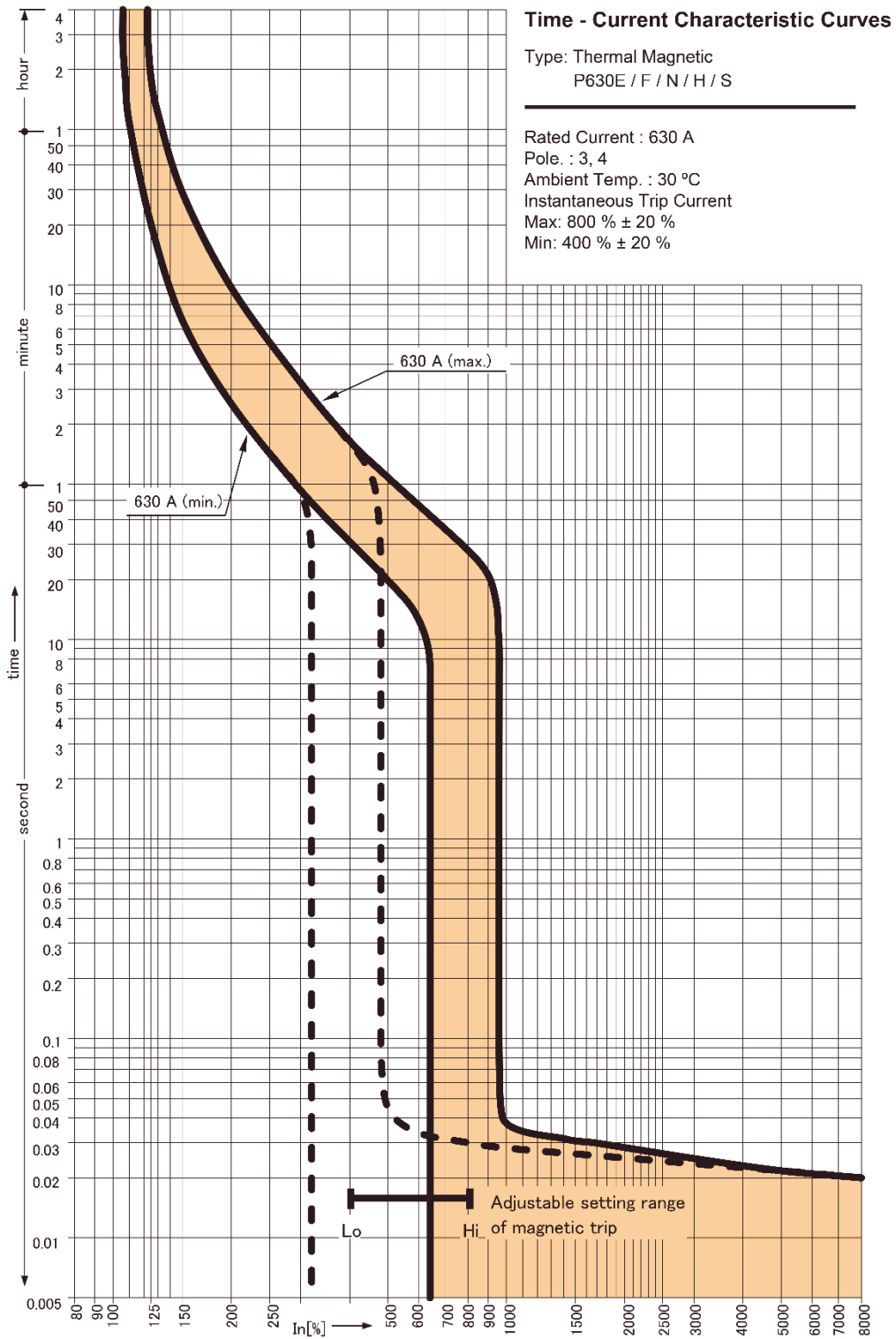

Annex C – I²t Let Through Curves

P160F / N / H

Let-through energy characteristics U = 380 ~ 415VAC

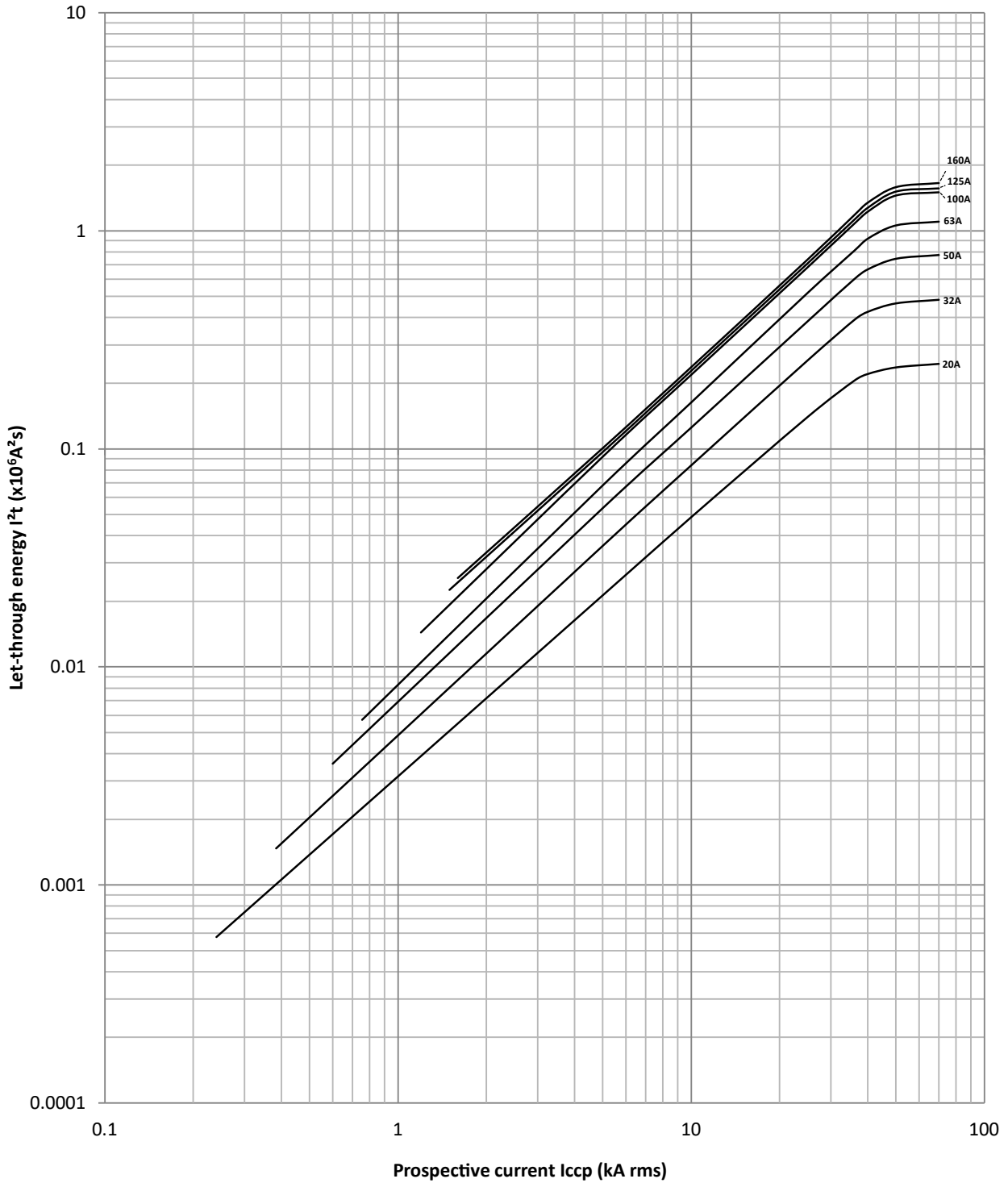

Annex C – I²t Let Through Curves

P250F / N / H

Let-through energy characteristics U = 380VAC ~415VAC

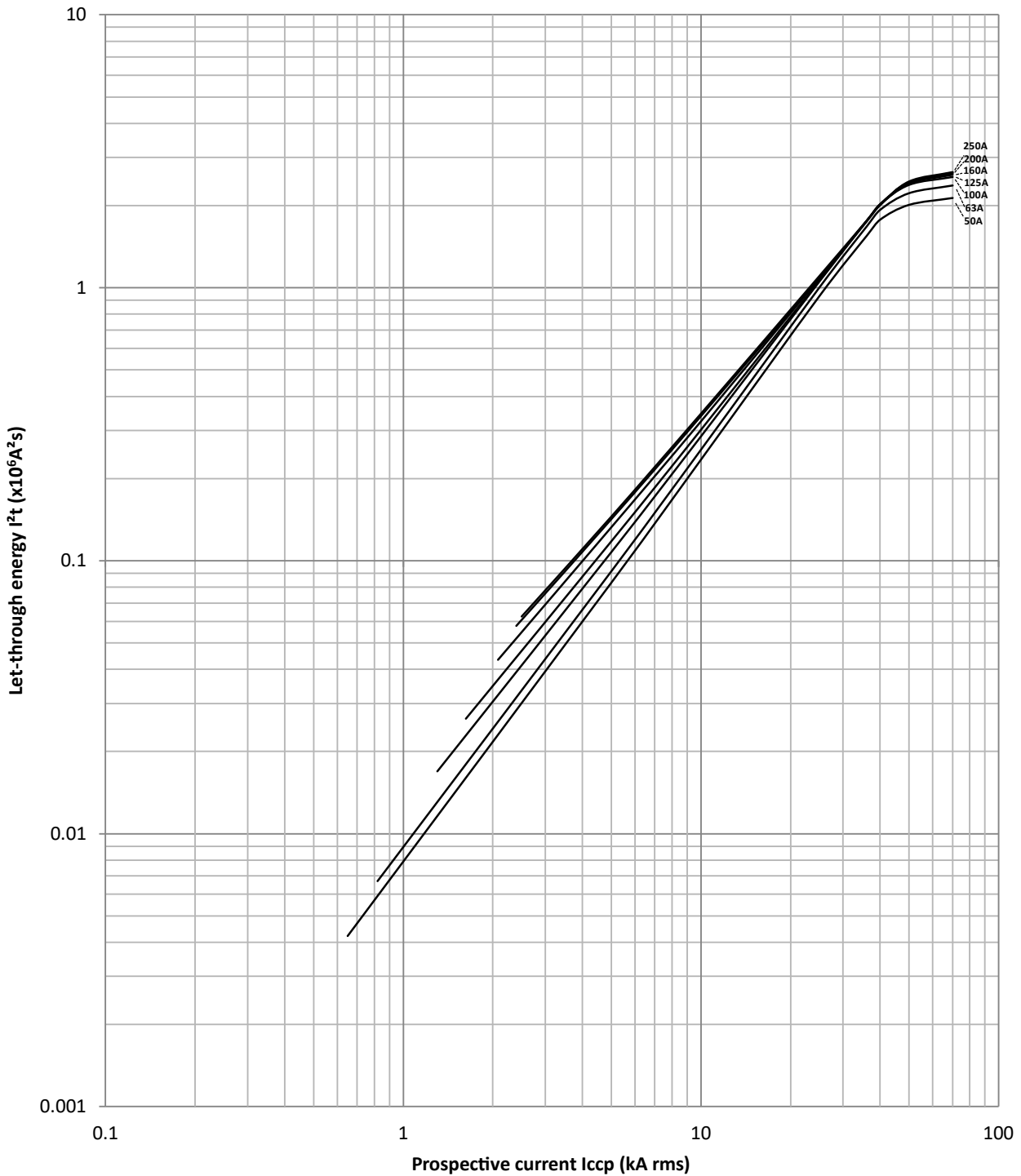

Annex C – I²t Let Through Curves

P400E / F / N / H / S

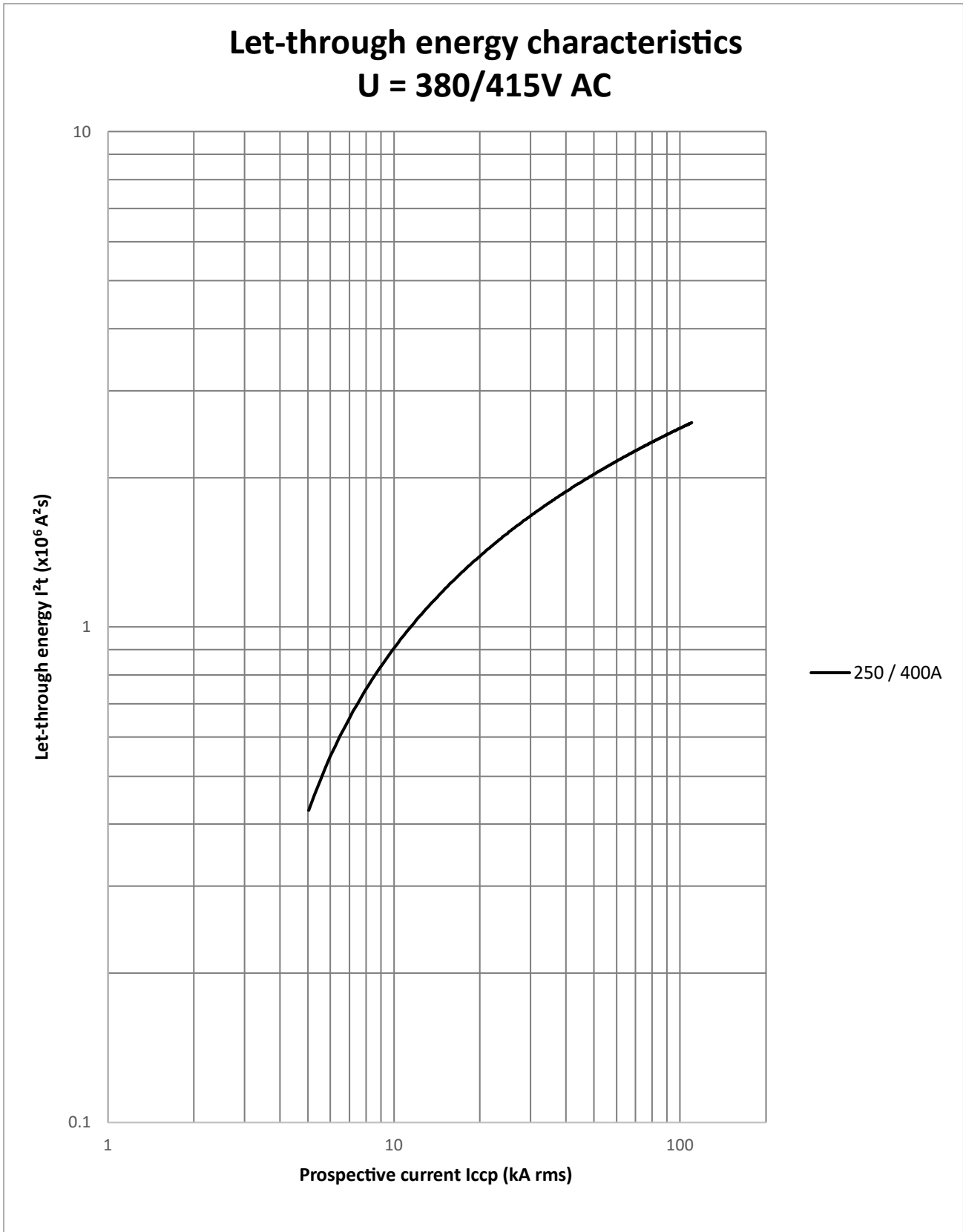

Annex C – I²t Let Through Curves

P630E/F/N/H/S

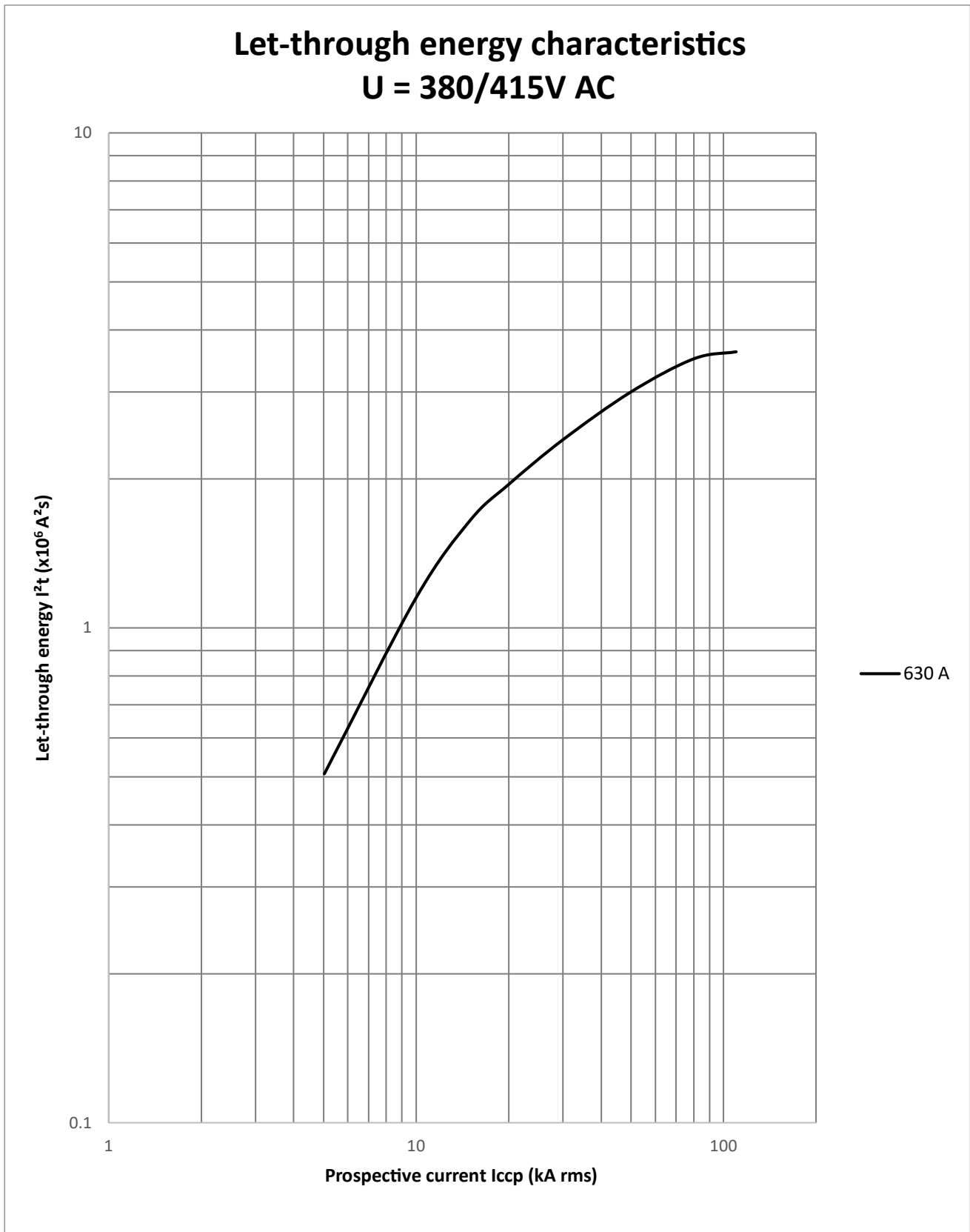

Annex D – Peak Let Through Curves

P160F / N / H

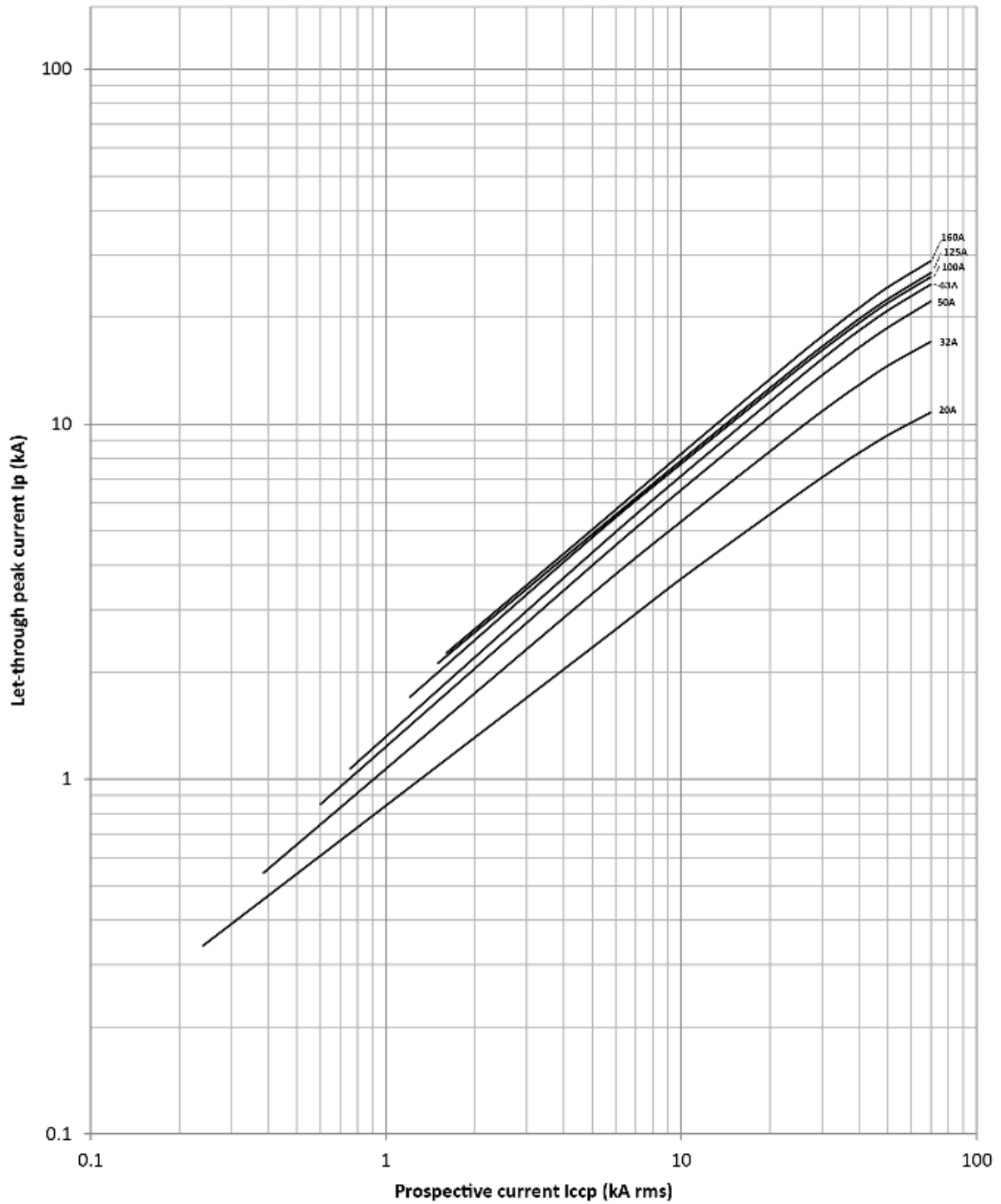

Annex D – Peak Let Through Curves

P250F / N / H

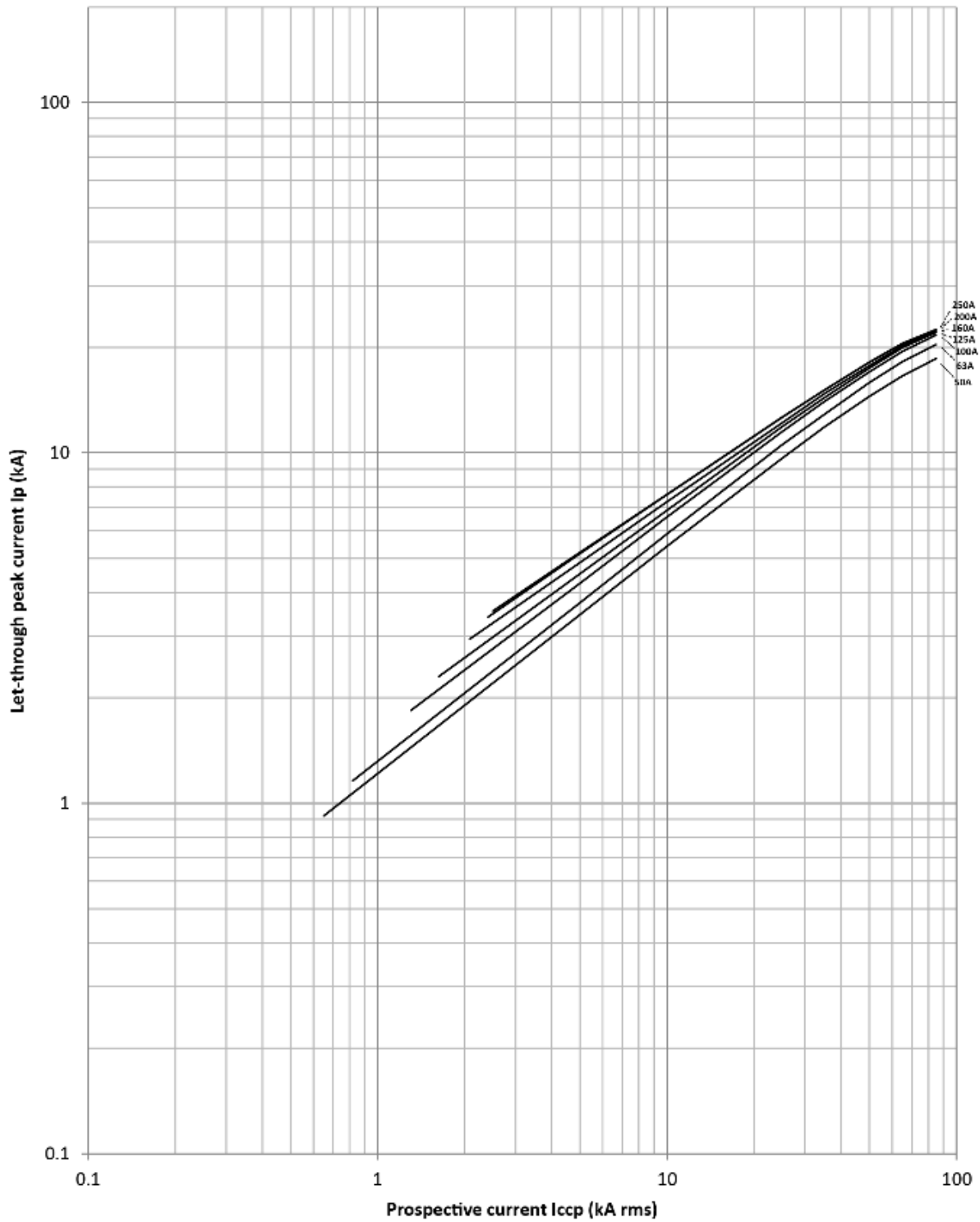

Annex D – Peak Let Through Curves

P400E/F/N/H/S
P630E/F/N/H/S

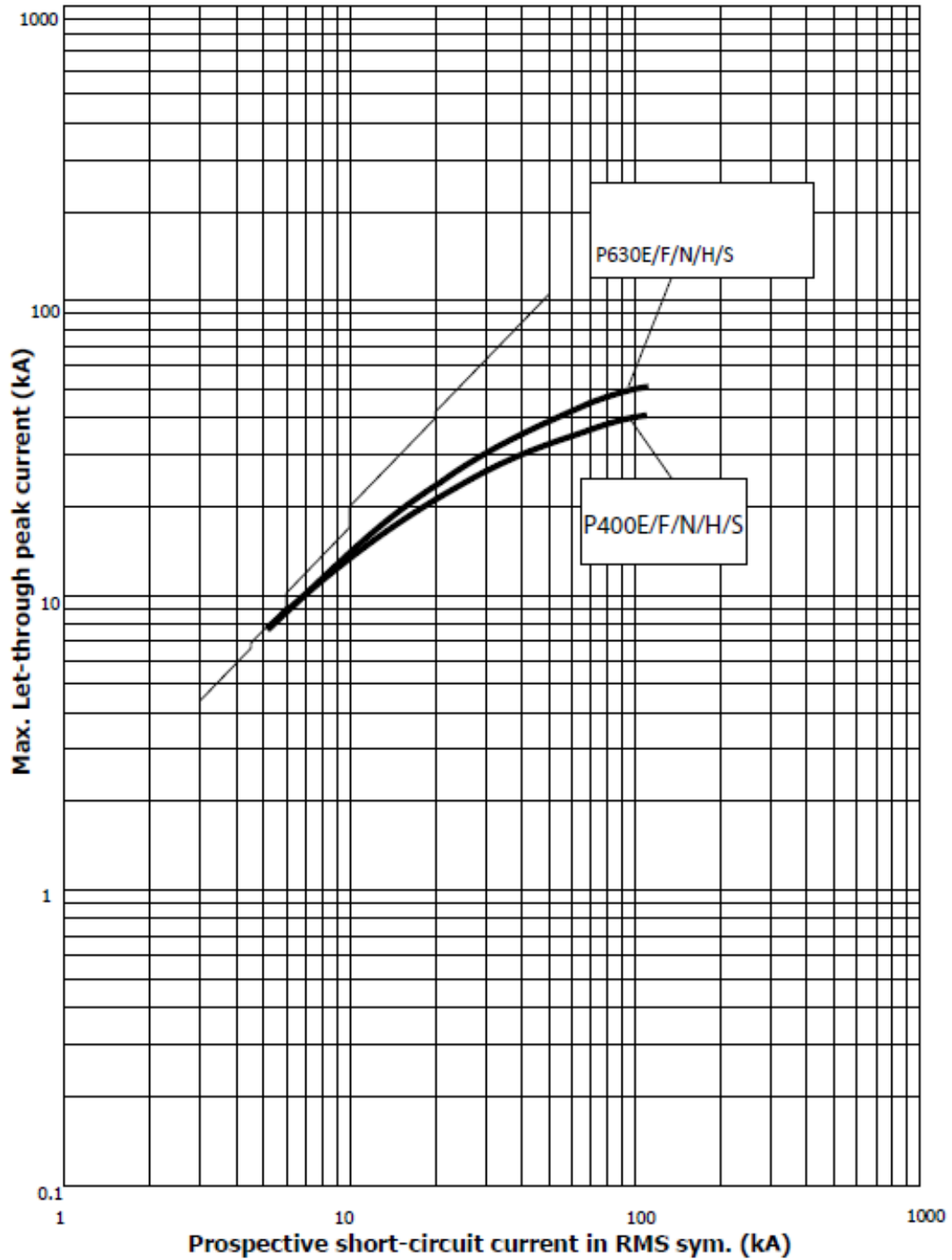

Annex E – Watts Loss

Impedance Watts Loss

Frame	Rating In (A)	Impedance per pole (mΩ)	Watts Loss per pole Based from Impedance (W)	Pole numbers	Watts Loss per product Based from Impedance (W)
P160F_FF	16	14.80	5	2P	10
	20	13.83	8.3		16.6
	30	6.67	9		18
	40	3.88	9.3		18.6
	50	2.00	7.5		15
	60	0.65	3.5		7
	75	0.70	5.9		11.8
	100	0.45	6.7		13.4
	125	0.46	10.7		21.4
P160_TM	20	20.75	8.3	3/4P	24.9
	32	8.79	9.0		27
	50	3.00	7.5		22.5
	63	0.88	3.5		10.5
	100	0.67	6.7		20.1
	125	0.68	10.7		32.1
	160	0.55	14.1		42.3
P250_TM	50	2.00	5.0	3/4P	15
	63	1.17	4.7		14.1
	100	0.60	6.0		18
	125	0.60	9.3		27.9
	160	0.38	9.7		29.1
	200	0.30	12.0		36
	250	0.27	16.9		50.7
P400_TM	250	0.36	22.3	3/4P	66.9
	400	0.27	42.4		127.2
P630_TM	630	0.16	62.3	3/4P	186.9

Annex E – Watts Loss

Resistance Watts Loss

Frame	Rating In (A)	Resistance per pole (mΩ)	Watts Loss per pole Based from Resistance (W)	Pole numbers	Watts Loss per product Based from Resistance (W)
P160F_FF	16	Contact NHP	Contact NHP	2P	Contact NHP
	20				
	30				
	40				
	50				
	60				
	75				
	100				
	125				
P160_TM	20	12.23	4.89	3/4P	14.67
	32	6.562	6.72		20.16
	50	1.74	4.35		13.05
	63	0.44	1.75		5.25
	100	0.335	3.35		10.05
	125	0.34	5.31		15.93
	160	0.275	7.04		21.12
P250_TM	50	0.995	2.49	3/4P	7.47
	63	0.595	2.36		7.08
	100	0.3	3.00		9
	125	0.3	4.69		14.07
	160	0.19	4.86		14.58
	200	0.145	5.80		17.4
	250	0.135	8.44		25.32
P400_TM	250	0.281	17.6	3/4P	52.8
	400	0.193	30.9		92.7
P630_TM	630	0.092	36.5	3/4P	109.5

Annex F – Temperature Derating

Front & Rear Connect

Calibration Temperature: 45°C								
MCCB Type	Connection type	Rated I _n	Rated Current (A)					
			45°C	50°C	55°C	60°C	65°C	70°C
P160F_FF	Front Conn. Rear Conn.	15A	15	13	12	11	9	Not Available
		20A	20	18	17	16	15	
		30A	30	28	27	25	24	
		40A	40	37	35	32	29	
		50A	50	47	44	40	37	
		60A	60	57	53	50	46	
		75A	75	72	69	65	62	
		100A	100	96	93	89	85	
125A	125	121	118	115	111			

Calibration Temperature: 50°C							
MCCB Type	Connection type	Rated I _n	Rated Current (A)				
			50°C	55°C	60°C	65°C	70°C
P160_TM	Front Conn. Rear Conn.	20A	20	19	19	18	17
		32A	32	31	30	29	28
		50A	50	47	45	42	39
		63A	63	59	54	49	43
		100A	100	97	93	89	85
		125A	125	121	118	115	110
P250_TM	Front Conn. Rear Conn.	50A	50	49	47	45	44
		63A	63	60	57	54	50
		100A	100	96	92	88	83
		125A	125	121	117	113	109
		160A	160	154	148	141	134
		200A	200	190	180	170	159
P400_TM	Front Conn. Rear Conn.	250A	250	242	233	224	215
		400A	400	392	384	376	368

Calibration Temperature: 30°C											
MCCB Type	Connection type	Rated I _n	Rated Current (A)								
			30°C	35°C	40°C	45°C	50°C	55°C	60°C	65°C	70°C
P630_TM	Front Conn. Rear Conn.	630A	630	615	600	577	560	540	520	500	479

Annex F – Temperature Derating

Plug-in Connect

Calibration Temperature: 50°C							
MCCB Type	Connection type	Rated I _n	Rated Current (A)				
			50°C	55°C	60°C	65°C	70°C
P160_TM	Plug-in Conn.	20A	20	19	19	18	17
		32A	32	31	30	29	28
		50A	50	47	45	42	39
		63A	63	59	54	49	43
		100A	100	97	93	89	85
		125A	125	121	118	115	110
		160A	Not Available in Plug-in				
P250_TM	Plug-in Conn.	50A	50	49	47	45	44
		63A	63	60	57	54	50
		100A	100	96	92	88	83
		125A	125	121	117	113	109
		160A	160	154	148	141	134
		200A	200	190	180	170	159
		250A	250	242	233	224	215
P400_TM	Plug-in Conn.	250A	250	244	238	233	226
		400A	400	392	384	376	368
P630_TM	Plug-in Conn.	630A	Not Available in Plug-in				



P_TM-UM-001-EN

Version

1.5.1

Published

11th May 2021