

Contactors, Overloads and Dol Starters

Easy selection guide



Follow the “3 Easy Steps” to select the right contactor for your application.

Step 1: Select Your Current Rating

Contactors are most commonly used in motor applications. Motor ratings are referred to as AC3 Amps or Motor Full Load Current (page 6).

What is the Motor Full Load Current?

This rating can be obtained from the nameplate of the motor or from the motor manufacturer. When selecting a CA7 contactor for the motor, be sure to refer to the column labelled as AC3 Amps.

There may be occasions where only the motor size (in kW) is supplied. Please use the table below to estimate the AC3 Amps rating.

Typical ratings for 3-phase motor

Motor size (kW)	Approx. full load current @ 415 V (AC 3 amps)
0.06	0.3
0.09	0.4
0.12	0.5
0.18	0.6
0.25	0.8
0.37	1.1
0.55	1.5
0.75	1.8
1.1	2.6
1.5	3.4
2.2	4.8
3.7	7.6
4	8.2
5.5	11
7.5	14
11	21
15	28
18.5	34
22	40
30	55
37	66
45	80
55	95

While contactors are most commonly used in motor applications, they can also be used with resistive loads such as a water heater. The ratings of these loads are referred to as nominal current.

These ratings are supplied by the manufacturer of the load. When selecting a CA7 contactor for resistive loads, be sure to refer to the column labelled AC 1 amps (page 6).

Step 2: Select Your Coil Voltage

CA7 contactors are most commonly supplied with a 240 V AC rated coil. However, they can be ordered complete with other coil voltages.

Coils are easily interchangeable for alternative coil voltages.

Select from 24, 110 and 415 V AC coils from the table labelled Spare Coils (page 7), and then follow the three easy steps to change from a standard 240 V AC coil to the alternative chosen.

Change your coil in three easy steps:

- 1) Place two “flat-head” screw drivers in position **1 and 2**. Unclip top half by pulling the clips back (away from the contactor).
- 2) Top half will spring off. Pull old coil out, and place spare in position **3**. Ensure spring is in place to mount top half above the new coil **4**.
- 3) Place the two screw drivers in positions **5 and 6**. Push clips back into their original position. Top half is now securely mounted and contactor is ready for use.

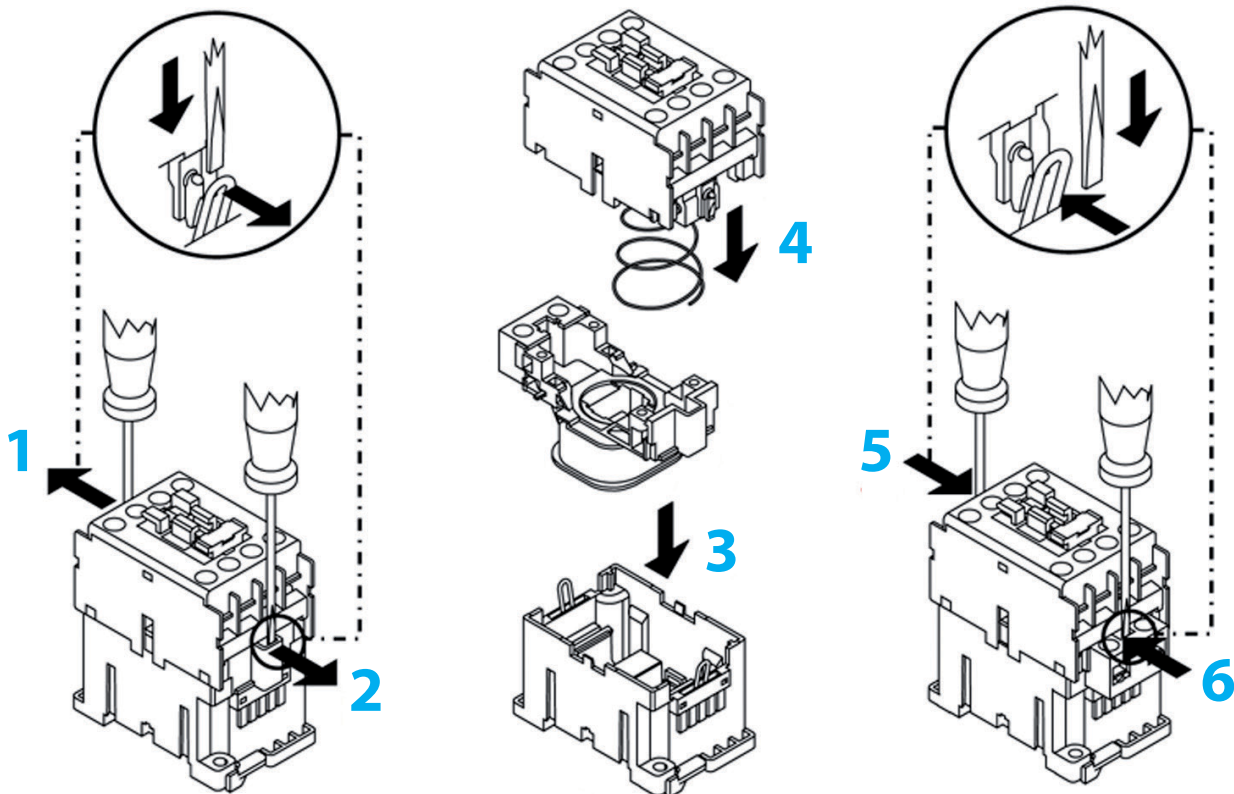

Step 3: Select Auxiliary Contacts (Optional)

As an additional option, CA7 contactors have auxiliary contacts.

CA7-9 to CA7-23 have either 1 x N/O or 1 x N/C auxiliary contact in-built.

CA7-30 to CA7-97 do not have in-built auxiliary contacts, therefore may require auxiliary contact blocks to be externally mounted. These can be mounted on the top or side of the CA7 contactors. When selecting an auxiliary contact block, please refer to the Auxiliary Contacts Blocks Table (page 6). These can be supplied separately.

CA7 clip-on accessory modules

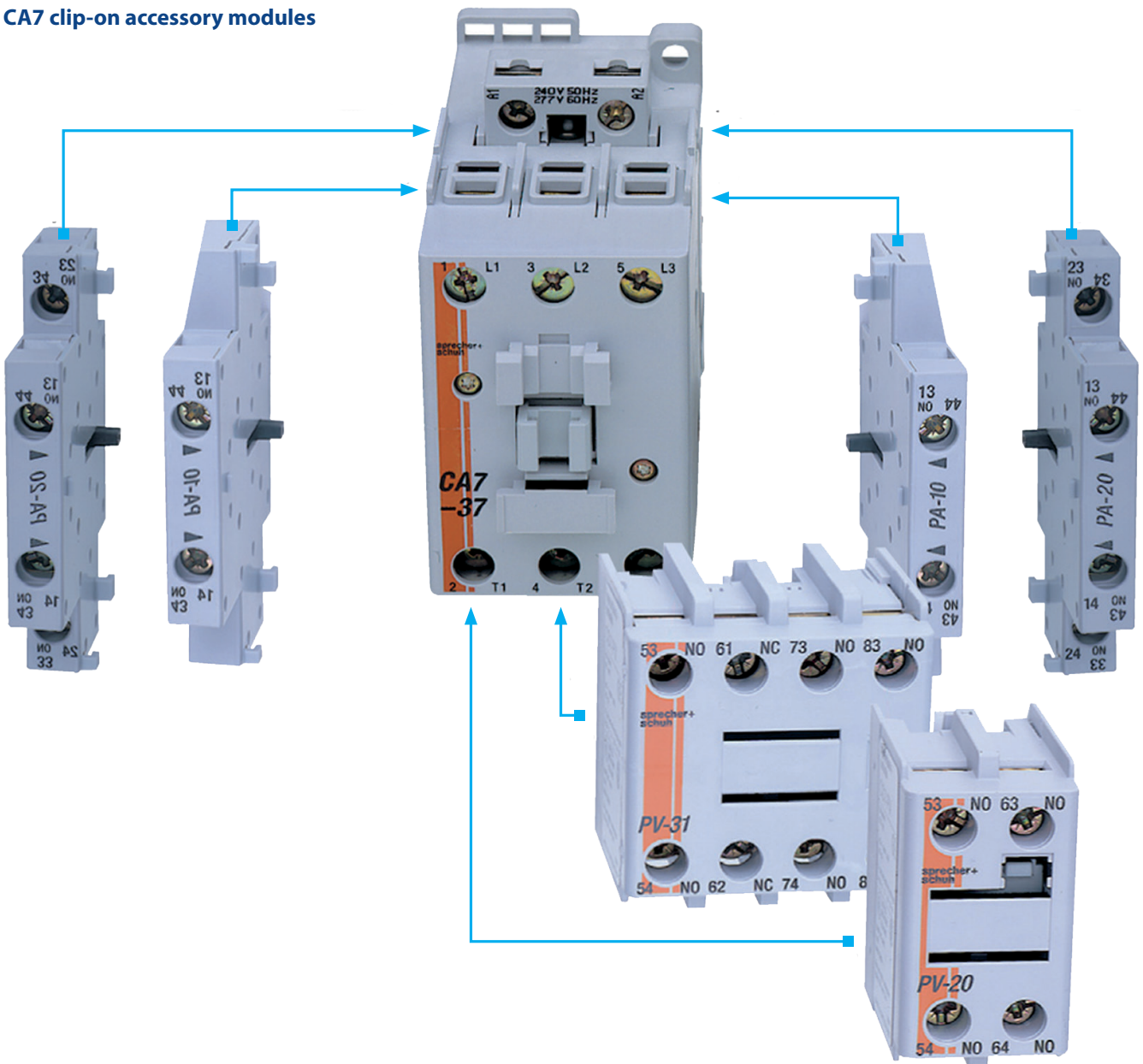

Examples

An Electrical fitter requires an AC contactor for a motor with full load current of 11 amps, a 240 V AC rated coil and 1 x N/C contact.

AC 3	AC 3	AC 1	Auxiliary Contacts		Catalogue No. ¹⁾
			Amps (415V, 60°C)	Motor size, kW (415V, 60°C)	
9	4	32	1	0	CA7-9-10-240V-AC
9	4	32	0	1	CA7-9-01-240V-AC
12	5.5	32	1	0	CA7-12-10-240V-AC
12	5.5	32	0	1	CA7-12-01-240V-AC
16	7.5	32	1	0	CA7-16-10-240V-AC
16	7.5	32	0	1	CA7-16-01-240V-AC
23	11	32	1	0	CA7-23-10-240V-AC
23	11	32	0	1	CA7-23-01-240V-AC
30	15	65	0	0	CA7-30-00-240V-AC
37	18.5	65	0	0	CA7-37-00-240V-AC
43	22	85	0	0	CA7-43-00-240V-AC
55	30	85	0	0	CA7-55-00-240V-AC
60	32	100	0	0	CA7-60-00-240V-AC
72	40	100	0	0	CA7-72-00-240V-AC
85	45	100	0	0	CA7-85-00-240V-AC
97	55	130	0	0	CA7-97-00-240V-AC

Select contactor rated up to 12 amps

240 V AC coil standard with CA7 contactors

Select contactor with 1 x N/C auxiliary contact

The fitter also requires an AC contactor for a motor with Full Load Current of 40 amps, a 24 V AC rated coil and 2 x N/O contacts.

AC 3	AC 3	AC 1	Auxiliary Contacts		Catalogue No. ¹⁾
			Amps (415V, 60°C)	Motor size, kW (415V, 60°C)	
9	4	32	1	0	CA7-9-10-240V-AC
9	4	32	0	1	CA7-9-01-240V-AC
12	5.5	32	1	0	CA7-12-10-240V-AC
12	5.5	32	0	1	CA7-12-01-240V-AC
16	7.5	32	1	0	CA7-16-10-240V-AC
16	7.5	32	0	1	CA7-16-01-240V-AC
23	11	32	1	0	CA7-23-10-240V-AC
23	11	32	0	1	CA7-23-01-240V-AC
30	15	65	0	0	CA7-30-00-240V-AC
37	18.5	65	0	0	CA7-37-00-240V-AC
43	22	85	0	0	CA7-43-00-240V-AC
55	30	85	0	0	CA7-55-00-240V-AC
60	32	100	0	0	CA7-60-00-240V-AC
72	40	100	0	0	CA7-72-00-240V-AC
85	45	100	0	0	CA7-85-00-240V-AC
97	55	130	0	0	CA7-97-00-240V-AC

Select contactor rated up to 43 amps

Fit new coil in contactor

Coils with alternative voltages for AC contactors	To suit	Cat. No.
24 V AC	CA7-9 to CA-16	CAC7-16-24V-AC
	CA7-23 to CA7-37	CAC7-37-24V-AC
	CA7-43 to CA7-55	CAC7-43-24V-AC
	CA7-60 to CA7-85	CAC7-85-24V-AC
	CA7-97	CAC7-97-24V-AC
110 V AC	CA7-9 to CA-16	CAC7-16-110V-AC
	CA7-23 to CA7-37	CAC7-37-110V-AC
	CA7-43 to CA7-55	CAC7-43-110V-AC
	CA7-60 to CA7-85	CAC7-85-110V-AC
	CA7-97	CAC7-97-110V-AC
240 V AC	CA7-9 to CA-16	CAC7-16-240V-AC
	CA7-23 to CA7-37	CAC7-37-240V-AC
	CA7-43 to CA7-55	CAC7-43-240V-AC
	CA7-60 to CA7-85	CAC7-85-240V-AC
	CA7-97	CAC7-97-240V-AC
415 V AC	CA7-9 to CA-16	CAC7-16-415V-AC
	CA7-23 to CA7-37	CAC7-37-415V-AC
	CA7-43 to CA7-55	CAC7-43-415V-AC
	CA7-60 to CA7-85	CAC7-85-415V-AC
	CA7-97	CAC7-97-415V-AC

Take 240 V AC coil out and select the following

Since no aux contacts with CA7-43, select the following aux contact block

No. of poles	Auxiliary contacts		Cat. No.
	N/O	N/C	
1	0	1	CA7-PA-01
1	1	0	CA7-PA-10
2	1	1	CS7-PA-11
2	2	0	CA7-PA-20

Supply aux contact block with CA7 contactor

Product Selection Tables

CA7 Contactors 4-55 kW with AC Coil

AC 3	AC 3	AC 1	Auxiliary Contacts		Catalogue No. ¹⁾
			N/O	N/C	
Amps (415V, 60°C)	Motor size, kW (415V, 60°C)	Amps (40°C)			
9	4	32	1	0	CA7-9-10-240V-AC
9	4	32	0	1	CA7-9-01-240V-AC
12	5.5	32	1	0	CA7-12-10-240V-AC
12	5.5	32	0	1	CA7-12-01-240V-AC
16	7.5	32	1	0	CA7-16-10-240V-AC
16	7.5	32	0	1	CA7-16-01-240V-AC
23	11	32	1	0	CA7-23-10-240V-AC
23	11	32	0	1	CA7-23-01-240V-AC
30	15	65	0	0	CA7-30-00-240V-AC
37	18.5	65	0	0	CA7-37-00-240V-AC
43	22	85	0	0	CA7-43-00-240V-AC
55	30	85	0	0	CA7-55-00-240V-AC
60	32	100	0	0	CA7-60-00-240V-AC
72	40	100	0	0	CA7-72-00-240V-AC
85	45	100	0	0	CA7-85-00-240V-AC
97	55	130	0	0	CA7-97-00-240V-AC

1) Contactors can be ordered complete with alternative coils. Replace 240 with 24, 110 & 415.

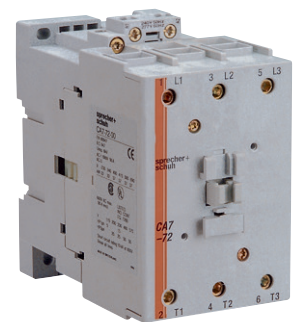
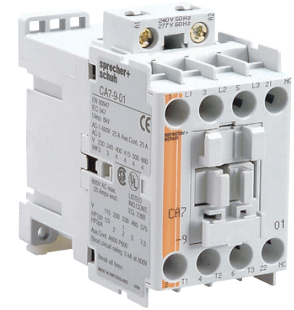

Auxiliary Contact Blocks (Top Mounting)²⁾

No. of poles	Auxiliary contacts		Suit CA7 ³⁾	Cat. No.
	N/O	N/C		
2	1	1	CA7-9 to CA7-23	CA7-PV-S11
2	1	1	CA7-30 to CA7-97	CA7-PV-11
2	1	1	All	CS7-PV-11
4	2	2	CA7-9 to CA7-23	CA7-PV-S22
4	2	2	CA7-30 to CA7-97	CA7-PV-22
4	4	0	All	CS7-PV-40

2) One top-mount auxiliary per contactor only.

3) Recommendation only. All auxiliary contacts will fit any CA7 contactor.



Auxiliary Contact Blocks (Side Mounting) ⁴⁾

No. of poles	Auxiliary contacts		Cat. No.
	N/O	N/C	
2	1	1	CA7-PV-S11
2	1	1	CA7-PV-11
2	1	1	CS7-PV-11
4	2	2	CA7-PV-S22
4	2	2	CA7-PV-22
4	4	0	CS7-PV-40

4) Two side-mount auxiliaries per contactor only (one on each side).
Side & top auxiliary contact blocks can be utilised together.



Spare Coils

Coils voltages	To suit	Cat. No.
24 V AC	CA7-9 to CA-16	CAC7-16-24V-AC
	CA7-23 to CA7-37	CAC7-37-24V-AC
	CA7-43 to CA7-55	CAC7-43-24V-AC
	CA7-60 to CA7-85	CAC7-85-24V-AC
	CA7-97	CAC7-97-24V-AC
110 V AC	CA7-9 to CA-16	CAC7-16-110V-AC
	CA7-23 to CA7-37	CAC7-37-110V-AC
	CA7-43 to CA7-55	CAC7-43-110V-AC
	CA7-60 to CA7-85	CAC7-85-110V-AC
	CA7-97	CAC7-97-110V-AC
240 V AC	CA7-9 to CA-16	CAC7-16-240V-AC
	CA7-23 to CA7-37	CAC7-37-240V-AC
	CA7-43 to CA7-55	CAC7-43-240V-AC
	CA7-60 to CA7-85	CAC7-85-240V-AC
	CA7-97	CAC7-97-240V-AC
415 V AC	CA7-9 to CA-16	CAC7-16-415V-AC
	CA7-23 to CA7-37	CAC7-37-415V-AC
	CA7-43 to CA7-55	CAC7-43-415V-AC
	CA7-60 to CA7-85	CAC7-85-415V-AC
	CA7-97	CAC7-97-415V-AC

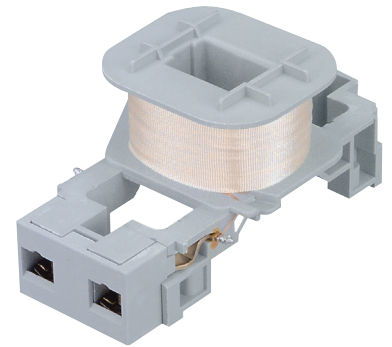

CA7 Contactors – Accessories & Spares

Function	Description	Cat. No.
pneumatic on-delay timer	time range	-
-	0.3 - 30 seconds	CZE7-30
-	1.8 - 180 seconds	CZE7-180
pneumatic off-delay timer	time range	-
-	0.3 - 30 seconds	CZA7-30
-	1.8 - 180 seconds	CZA7-180
-	-	-
mechanical interlock	interlock only	CM7
-	Interlock with 2 x N/C	CM7-02
electronic PLC interface ¹⁾	Digital input	-
-	18 - 30 V DC (10 - 15mA)	CRI7E

1) Suitable for control voltages between 110 and 240 V AC.

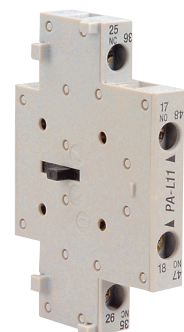
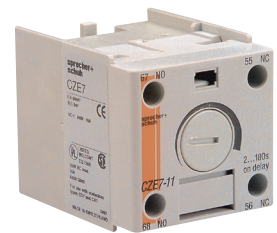

Bi-Metal Thermal Overloads

To choose your Bi-Metal Thermal Overload, check the motor name plate for the full load current and match it to the "Adjustment Range (A)". Also ensure the overload selected suits the CA7 contactor.

Approx. motor size (kW)	Adjustment Range (A)	To suit contactor	Cat. No.
–	0.1 to 0.16	CA7-9 to CA7-23	CT7N-23-A16
–	0.16 to 0.25	CA7-9 to CA7-23	CT7N-23-A25
0.06 to 0.09	0.25 to 0.40	CA7-9 to CA7-23	CT7N-23-A40
0.09 to 0.12	0.35 to 0.50	CA7-9 to CA7-23	CT7N-23-A50
0.18	0.45 to 0.63	CA7-9 to CA7-23	CT7N-23-A63
0.18 to 0.25	0.55 to 0.80	CA7-9 to CA7-23	CT7N-23-A80
0.25	0.75 to 1.0	CA7-9 to CA7-23	CT7N-23-B10
0.37	0.9 to 1.3	CA7-9 to CA7-23	CT7N-23-B13
0.55	1.1 to 1.6	CA7-9 to CA7-23	CT7N-23-B16
0.55 to 0.75	1.4 to 2.0	CA7-9 to CA7-23	CT7N-23-B20
0.72 to 1.1	1.8 to 2.5	CA7-9 to CA7-23	CT7N-23-B25
1.1	2.3 to 3.2	CA7-9 to CA7-23	CT7N-23-B32
1.5	2.9 to 4.0	CA7-9 to CA7-23	CT7N-23-B40
2.2	3.5 to 4.8	CA7-9 to CA7-23	CT7N-23-B48
2.2	4.5 to 6.3	CA7-9 to CA7-23	CT 7N-23-B63
–	5.5 to 7.5	CA7-9 to CA7-23	CT7N-23-B75
3.7	7.2 to 10	CA7-9 to CA7-23	CT7N-23-C10
5.5	9 to 12.5	CA7-12 to CA7-23	CT7N-23-C12
5.5	11.3 to 16	CA7-16 to CA7-23	CT7N-23-C16
7.5	15 to 20	CA7-16 to CA7-23	CT7N-23-C20
–	17.5 to 21.5	CA7-16 to CA7-23	CT7N-23-C21
11	21 to 25	CA7-16 to CA7-23	CT7N-23-C25
7.5	15 to 20	CA7-30 to CA7-37	CT7N-37-C20
11	17.5 to 21.5	CA7-30 to CA7-37	CT7N-37-C21
11	21 to 25	CA7-30 to CA7-37	CT7N-37-C25
15	24.5 to 30	CA7-30 to CA7-37	CT7N-37-C30
18.5	29 to 36	CA7-30 to CA7-37	CT7N-37-C36
18.5	33 to 38	CA7-30 to CA7-37	CT7N-37-C38
11	17 to 25	CA7-43 to CA7-55	CT7N-43-C25
15 to 18.5	24.5 to 36	CA7-43 to CA7-55	CT7N-43-C36
18.5 to 22	35 to 47	CA7-43 to CA7-55	CT7N-43-C47
18.5 to 22	35 to 47	CA7-60 to CA7-97	CT7N-85-C47
30	45 to 60	CA7-43 to CA7-55	CT7N-55-C60
30	45 to 60	CA7-60 to CA7-97	CT7N-85-C60
37	58 to 75	CA7-60 to CA7-97	CT7N-85-C75
45	72 to 90	CA7-60 to CA7-97	CT7N-85-C90



CT 7N

- Bi-Metal thermal overload for standard motors up to 45 kW
- Manual reset
- Standard trip class 10 overload curve
- Suitable for single phase and 3-phase applications

Electronic Overloads

To choose your Electronic Overload, check the motor name plate for the full load current and match it to the "Adjustment Range (A)". Also ensure the overload selected suits the CA7 contactor.

CEP7-1EE

- Standard overload for motors up to 55 kW
- Reduced power consumption and heat output
- Manual reset button
- Reduces stock levels due to wide current adjustment range
- Selectable trip class 10 and 20 overload curve (dip switches)
- Suitable for single phase and 3-phase applications



Approx. motor size (kW)	Adjustment Range (A)	To suit contactor	Cat. No.
0.02 to 0.12	0.1 to 0.5	CA7-9 to CA7-23	CEP7-1EEAB
0.06 to 0.25	0.2 to 1.0	CA7-9 to CA7-23	CEP7-1EEBB
0.25 to 2.2	1.0 to 5.0	CA7-9 to CA7-23	CEP7-1EECB
1.5 to 7.5	3.2 to 16	CA7-9 to CA7-23	CEP7-1EEDB
2.2 to 15	5.4 to 27	CA7-9 to CA7-23	CEP7-1EEEB
2.2 to 15	5.4 to 27	CA7-30 to CA7-55	CEP7-1EEED
5.5 to 30	11 to 55	CA7-30 to CA7-55	CEP7-1EEFD
11 to 55	20 to 100	CA7-60 to CA7-97	CEP7-1EEGE

CEP7-1EF 1)

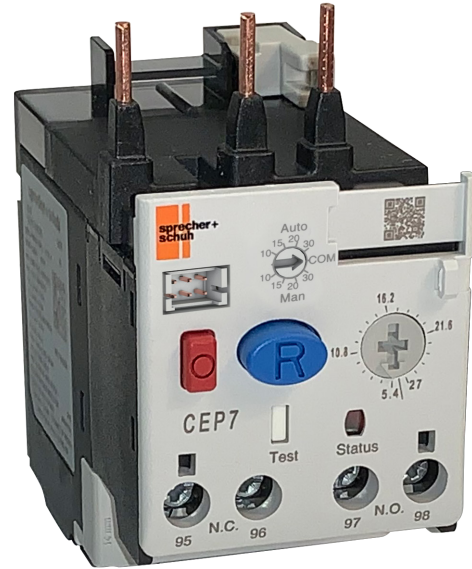

- Enhanced overload for motors up to 55 kW
- Accepts optional accessory modules via module port
- Reduced power consumption and heat output
- Ideal for motors with longer run up times
- Automatic and manual reset button
- Selectable trip classes- 10, 15, 20, 30 (selectable dial)
- Suitable for single phase and 3-phase applications



Approx. motor size (kW)	Adjustment Range (A)	To suit contactor	Cat. No.
0.02 to 0.12	0.1 to 0.5	CA7-9 to CA7-23	CEP7-1EFAB
0.06 to 0.25	0.2 to 1.0	CA7-9 to CA7-23	CEP7-1EFBB
0.25 to 2.2	1.0 to 5.0	CA7-9 to CA7-23	CEP7-1EFCB
1.5 to 7.5	3.2 to 16	CA7-9 to CA7-23	CEP7-1EFDB
2.2 to 15	5.4 to 27	CA7-9 to CA7-23	CEP7-1EFEB
2.2 to 15	5.4 to 27	CA7-30 to CA7-55	CEP7-1EFED
5.5 to 30	11 to 55	CA7-30 to CA7-55	CEP7-1EFFD
11 to 55	20 to 100	CA7-60 to CA7-97	CEP7-1EFGE

1) For higher kW ratings refer to NHP website www.nhp.com.au

Overload Accessories

	Function	Description	To suit overload	Cat. No.
	Remote reset module	For remote reset after an overload trip	CT7N Range	CMR7N-240VAC 1)
	Remote reset module	For remote reset after an overload trip	CEP7-1 Range	CEP7-1EMR* 2)

1) Change control voltage to Cat. No. when ordering 24, 110V AC or 24, 48V DC
 2) Replace "*" with voltage code: A = 240V AC, D = 120V AC, Z = 24V DC

DOL Starters

1. Select Enclosure Type with CA7 Contactor

To choose your bi-metal thermal overload, check the motor name plate for the full load current and match it to the "motor current range (A)". Also ensure the overload selected suits the CA7 contactor.

	Approx. motor kW range	Contactor type	Thermal overload type ¹⁾	Cat. No. ²⁾
Insulated enclosure with green start and red stop button	5.5	CA7-12	CT7N	CAT7N-5.5P-240-VAC
	7.5	CA7-16	CT7N	CAT7N-7.5P-240-VAC
Insulated enclosure with blue reset button only	5.5	CA7-12	CT7N	CAT7N-5.5R-240-VAC
	7.5	CA7-16	CT7N	CAT7N-7.5R-240-VAC
Insulated enclosure with green start and red mushroom stop button	5.5	CA7-12	CT7N	CAT7N-5.5PM-240-VAC

1) Starter supplied less overload, select overload from list on page 13.

2) For 3-phase voltage, add 415 in place of 240.



Note: CEP7-1EE/EF electronic overloads are not suitable for use in CAT7N-5.5/7.5 enclosures

2. Select Thermal Bi-Metal Overload

For typical motor applications with standard motor size select Thermal Bi-Metal Overload.

Approx. motor kW range	Adjustment Range (A)	Cat. No. ²⁾
–	0.1 to 0.16	CT7N-23-A16
–	0.16 to 0.25	CT7N-23-A25
–	0.25 to 0.40	CT7N-23-A40
–	0.35 to 0.50	CT7N-23-A50
0.18	0.45 to 0.63	CT7N-23-A63
0.18 to 0.25	0.55 to 0.80	CT7N-23-A80
0.25	0.75 to 1.0	CT7N-23-B10
0.37	0.9 to 1.3	CT7N-23-B13
0.55	1.1 to 1.6	CT7N-23-B16
0.55 to 0.75	1.4 to 2.0	CT7N-23-B20
0.75 to 1.1	1.8 to 2.5	CT7N-23-B25
1.1	2.3 to 3.2	CT7N-23-B32
1.5	2.9 to 4.0	CT7N-23-B40
2.2	3.5 to 4.8	CT7N-23-B48
2.2	4.5 to 6.3	CT7N-23-B63
2.2 to 3.7	5.5 to 7.5	CT7N-23-B75
3.7	7.2 to 10	CT7N-23-C10
5.5	9 to 12.5	CT7N-23-C12
5.5	11.3 to 16	CT7N-23-C16
7.5	15 to 20	CT7N-23-C20

NHP Training University (NTU)

Have you ever thought about increasing your skill set, but wanted to avoid boring lectures and the cost of further education? Now you can with NHP Training University (NTU)!

With new and interesting training modules introduced regularly, NTU is a constantly evolving free training program designed to help further your knowledge in key electrotechnology areas.

NTU is also compatible with tablet, mobile and desktop devices and all training is free.

So what are you waiting for? Put yourself on the path to success sooner!

What can I expect to learn?

Training modules include:

- Signalling Devices
- Panelboards & Load centres
- MCBs & RCDs
- Machine Safety Control Systems
- Hazardous Area
- Enclosures
- Climate Control
- EV Chargers
- Electromechanical Relays
- Contactors and Overloads
- Motorstarters and Controllers
- Operator Control Devices
- Variable Speed Drives

Stay tuned for more modules!



How can I get involved?

To access the NTU content please reach out to NHP today





nhp.com.au
SALES 1300 NHP NHP
sales@nhp.com.au

nhp-nz.com
SALES 0800 NHP NHP
sales@nhp-nz.com

NHP Electrical Engineering Products

A.B.N. 84 004 304 812

© COPYRIGHT NHP 2020

NHP17BCH 02/21